

1. Cotton Gloves



2. Multi-Purpose Rubber Coated Gloves



3. Polka Dot Gloves



4. Argon Coated Leather Gloves



5. Semi Leather Gloves



6. Heat Resistant Gloves



7. Full Leather Glove



8. Leather Protector Gloves



9. Nitrile Gloves 13" / 18"



10. Neoprene Gloves



11. Latex / Nitrile Disposable Gloves



12. Rubber Insulating Gloves



13. Cut Resistant Gloves



14. MAPA 395 Gloves (Cut, Acid, Heat Resistant)



15. Stainless Steel Gloves

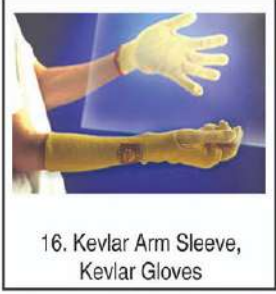

16. Kevlar Arm Sleeve, Kevlar Gloves



17. Fireman Gloves



18. Cut Resistant & PU Palm Glove Cirrus (Lev 3)



19. Cut Resistant & Nitrile Micro Foam Glove Sapphire (Lev F)



20. Touch Screen, Nitrile Foam Palm Glove Aria 360



21. Multipurpose Oil Task Glove BMG 201



22. Lab Coat



23. PE Disposable Apron



24. PVC / Neoprene Apron



25. Anti Static Smock Jumpsuit



26. Cotton Coverall / Jacket



27. Portwest Disposable / Chemical Coverall



28. Elastic Vest



29. Customade Safety Vest



30. Netting Safety Vest



31. V Fabric Vest



Arc Flash Kit

32. ARC Flash Kit Products



33. Welding Garments



34. 3 Ply / 4 Ply Carbon Mask (Ear Loop / Tie-On)



35. Disposable Mask



36. Honeywell N95 H910 Plus Mask



37. Dräger Half Face 3500 Mask



38. Dräger Full Face X-plore 5500 Mask (Twin Filter)



39. Dräger Full Face X-plore 6300 Mask (Single Cartridge)



40. Dräger X-plore 1720V



41. Dräger Single Gas Filters (6738797) A2B2E2K2HgP3 R D



42. Dräger X-Plore Pad Retainer (6738038)



43. Dräger X-Plore Pad P2 R (6738002)



44. Dräger X-Plore Pad Base (6738039)



45. Dräger X-Plore Pure P3 R (6738354)



46. Dräger Particle Filter Bayonet P3 R (6738011)



47. Dräger Combi Filter Bayonet (6738817) A1B1E1K1HgP3 R D (Multi Gas, Organic Vapours, Mercury & Ammonia Filter)



48. Dräger X-Plore Gas Filter A1 (6738872) (Organic Vapours Filter)

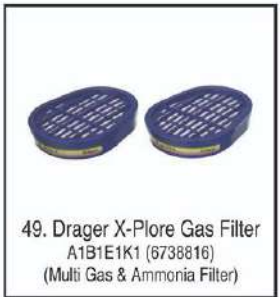

49. Dräger X-Plore Gas Filter A1B1E1K1 (6738816) (Multi Gas & Ammonia Filter)



50. Dräger X-Plore Gas Filter A1B1E1 (6738778) (Multi Gas & Organic Vapours Filter)



51. 3M Ultrafit Earplug SNR 29 db



52. Honeywell Disposable Earplug 33 db



53. 3M Disposable Earplug SNR 35db

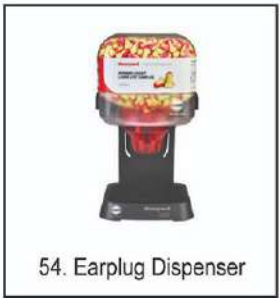

54. Earplug Dispenser



55. 3M Ear Muff



56. Centurion SANA Ear Muff



57. Honeywell Ear Muff

CENTURION® Martindale®

58. Head & Face Protection



59. ArcPro Anti Electric Arc System



60. New -Tech Welding Shield



61. 1125 Safety Helmet



62. Vision / Spectrum Safety Helmet

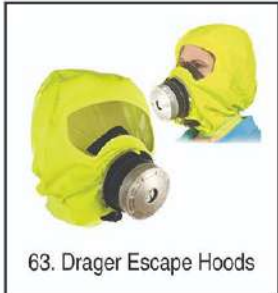

63. Dräger Escape Hoods

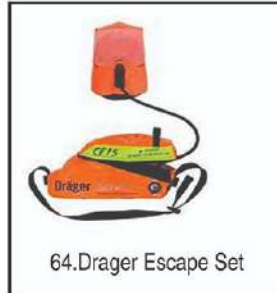

64. Dräger Escape Set



65. Nexus Core Safety Helmet



66. High Intensity Reflective Sticker

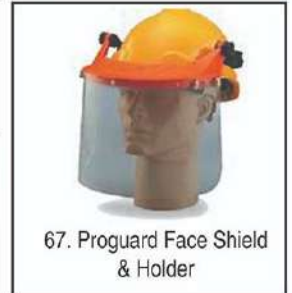

67. Proguard Face Shield & Holder



68. Safety Helmet Ratchet



69. Safety Helmet PHSL



70. Head Lamp



71. Pelican Torch Light



72. Tilla Eyewear



73. Flux Eyewear



74. Merlin Eyewear



75. Worksafe Firefly Eyewear

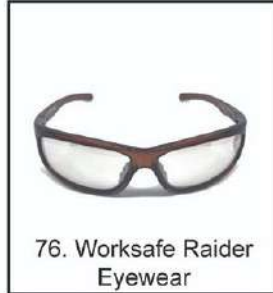

76. Worksafe Raider Eyewear



77. Velia Google



78. Overspec



79. 3M Safety Goggle



80. Service, Inspection & Rental Services for Dräger SCBA Set



81. Deb Oxybac Antibacterial Hand Wash



82. Deb @ Instant Foam Hand Sanitiser



83. Deb Stoko Protect Cream



84. Swarfega Heavy Duty Hand Cleaner



85. Deb Suprega Plus Heavy Duty Hand Cleaner



86. Deb Hand Wash Refresh Foam



87. Deb Hair & Body Shampoo



88. Deb Gritty Foam Heavy Duty Cleaner



89. Mercury Spill Kit



90. 3M Spill Sorbent Kit



91. 3M Spill Kit 31 gal



92. 120L or 240L Dispenser Cart Spill Kit



93. 20L Portable Spill Kit



94. SPC Economy Portable Spill Kit



95. Clinical Waste Bin (10, 18, 35 L)



96. Biohazard Step Bin



97. SPC Allwik Kaddie Sorbent



98. Hazardous Material Disposal Bag



99. Shoes Cover & Clip Cap



100. Arm Sleeve Cover



101. Knee length boot cover



102. Isolation Suit



103. CPE Isolation Gown



104. Eyewash Saline Solution



105. Guardian Eye Wash Water Preservative



106. Emergency Oxygen Set



107. Safety Knife



108. ARSCK



1. Biohazard Zip Lock Bag
2. Confirming Blood Stopper
3. Crepe Bandage / W.O.W
4. PE Blue Plaster (Metal Detectable) / Assorted Elastic Fabric Plaster
5. Burn Shield Burn Dressing
6. Ice Pack

109. First Aid Kit Refill Content

110. King's Safety Shoes



KWS 200



KWD 207



KINGS by Honeywell



KWD 106



KWD 206



KWD 301



KWD 205

111. Topsafe Safety Shoes



TS321



TS8304



TS303



TS501



TS901

112. Nitti Safety Shoes



Low Cut 21281



Low Cut 21981



Mid Cut 22281



Mid Cut 22681



High Cut 23281

113. Jogger Safety Shoes



GUSTO S2



CERES

114. Oscar Safety Shoes



802



829



830



1902



172



903



127



128



805



806



136



808

115. Black Hammer Safety Shoes



BH 4666



BH 4663



BH 4660



S114

116. Deltaplus Safety Shoes



Miami S1



Miami S2



Deltasport



Gargas II



Jet 3 S1

117. Neuking Safety Shoes



NK60



NK63



NK67



NH65



NKL20



NKL29



NKC 90K



NKC93K



NKC95

118. ASYS Safety Shoes



Godzilla Osaka Samurai Z1281

119. Rubber Safety Boots / PVC Boots



120. Red Wing Safety Shoes



121. BATA Safety Shoes



804-43800

122. Fireman Boots



123. Safety Padlock with Compact Cable 20cm / 40cm



124. Clamp On Breaker Lockout / Oversized Clamp On



125. Durable Standard Ball Valve Lockout Devices



126. Adjustable Ball Valve Lockout



127. Gate Valve Lockout



128. Adjustable Gate Valve Lockout



129. 120 / 277V Breaker Lockout Pouch



130. Valve Lockout Pouch Kit



131. Lockout Tagout Station Equipment

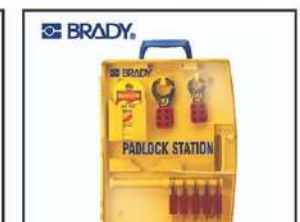

132. Padlock Station

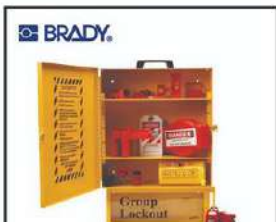

133. Combined Lockout & Lock Box Station

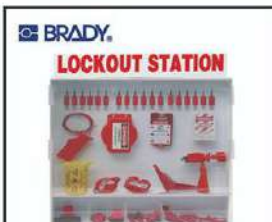

134. Extra Large Enclosed Lockout Station



135. Hasps



136. All Purpose Cable Lockout



137. Butterfly Valve Lockout



138. Transparent Emergency Stop Lockout for Wall Switch



139. Butterfly Valve Lockout

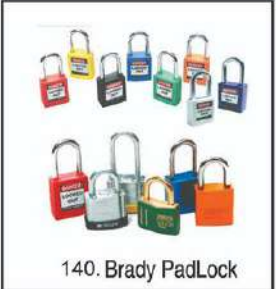

140. Brady PadLock



141. Switch and Button Emergency Stop Lockout



142. Control Panel Lockout for Touch Panel



143. Medium Circuit Breaker Lockout

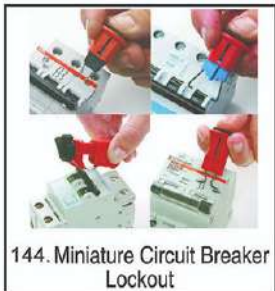

144. Miniature Circuit Breaker Lockout

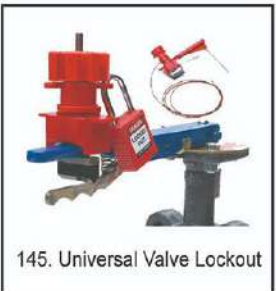

145. Universal Valve Lockout



146. SDS Station



147. Brady Label Printer



148. Weight Scale



149. Kitchen Mat



150. Switchboard Matting



151. Sticky Blue Mat



152. Anti Slip Plate



153. Outdoor Anti Slip For Stair Nosing & Ladder Rung

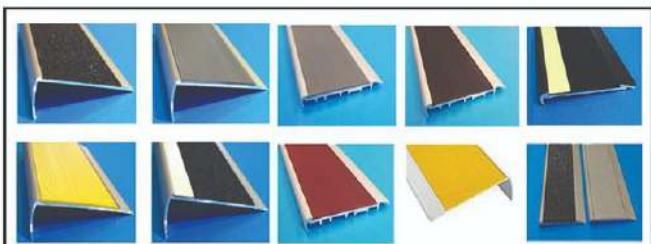

154. Indoor Anti Slip Stair Nosing



155. Anti Fatigue Mat



156. Bus/Truck Wheel Stopper



157. Rubber Hump



158. Channel Cable Hump / Kerb Ramp

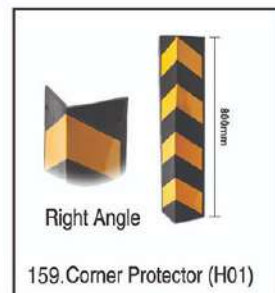

159. Corner Protector (H01)



160. Rubber Wheel Chock (190 W x 170 H x 240mm L)

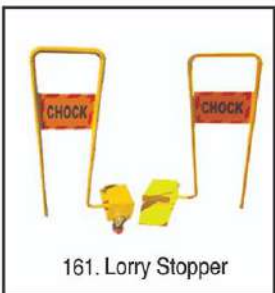

161. Lorry Stopper



162. Trailer & Car Clamp

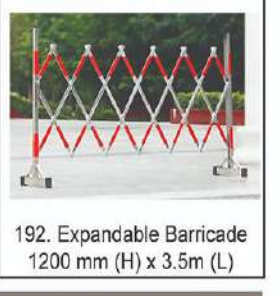
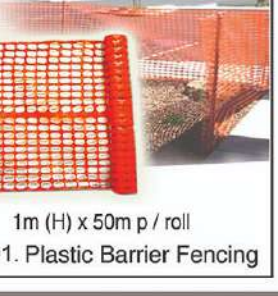
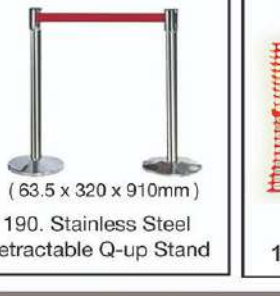
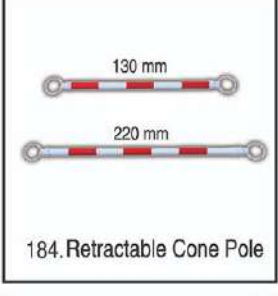
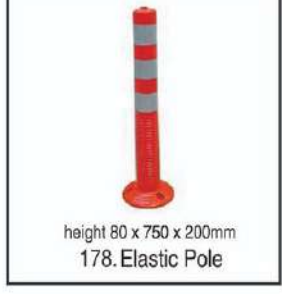
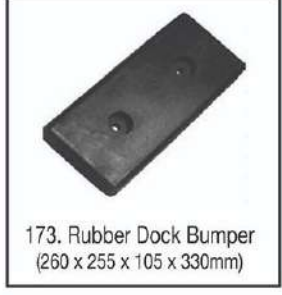
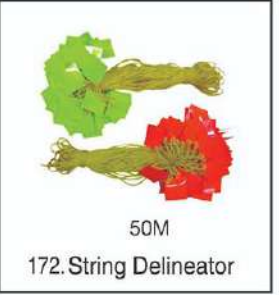
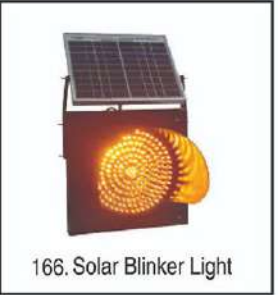
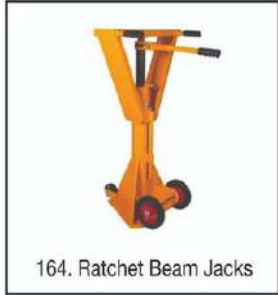
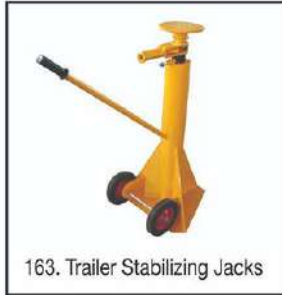

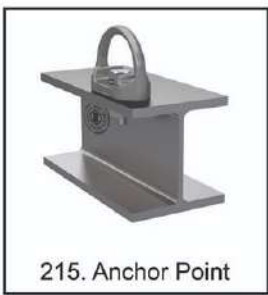

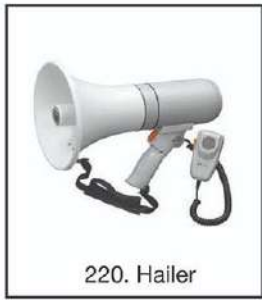

220. Hailer

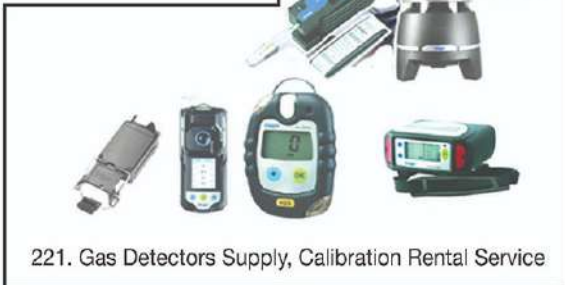

221. Gas Detectors Supply, Calibration Rental Service



222. Fire Fighting Equipment



223. Fireman Helmet



224. Dräger SCBA Mask & Cylinder Cover



225. Smoke Tester



226. Ultra Light Bump Cap



227. Coldstore Jacket



228. Fireman Suit



229. Rain Suit



230. NOMEX IIIA Coverall



231. Aluminium Coat / Dräger CPS 5900, 7900



232. S. Steel / Mild Steel Cabinet



233. Inflatable Life Jacket



234. Life Jacket



235. Stearns I222



236. Cosalt Life Jacket

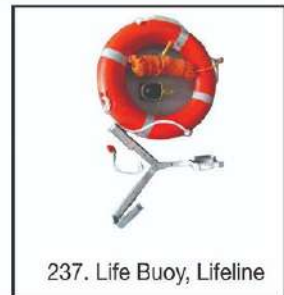

237. Life Buoy, Lifeline



238. Jobbird Cabinet



239. Helicopter Crash Rescue Equipment



240. Marine Life Jacket Lights / Whistle



241. Life Buoy Light

Escape Chute Systems

Fire Emergency Escape

Oil Rig Emergency Egress System

IECS & LR

Integrated Escape Chute and Life Raft

 A collage of images showing escape chute systems on an oil rig, a yellow escape chute box, a 3D cutaway of a chute, and a person in a life raft.

242. Escape Chute System Products



243. Life Raft



244. Static Rope



245. Wind Sock, Swivel Hoop, Swivel Arm



246. Billy Pugh Marine Cargo Basket



247. GlideLoc Vertical Lifeline Ladder System



248. Vertical Lifeline / Installation / Inspection



249. Clawline system & Skytac Rail

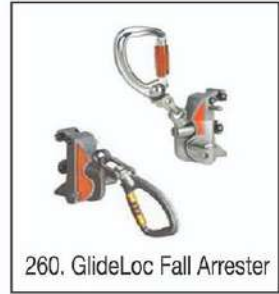

How To Order ?

Mandatory Sign

STEP : Codes >

Size

300mm (H) x 200mm (W)
400mm (H) x 300mm (W)
600mm (H) x 400mm (W)

Material

THK 1.5mm PVC
THK 3.0mm Aluminium Composite
Self Adhesive Vinyl Sticker

 Gunakan Topi Keselamatan Wear Safety Helmet MS 001	 Gunakan Topi Keselamatan Dengan Tali Dagu Wear Safety Helmet with Chin Strap MS 002	 Gunakan Pelindung Mata Wear Eye Protection MS 003	 Gunakan Pelindung Telinga Wear Ear Protection MS 004	 Gunakan Pelindung Muka Wear Face Shield MS 005	 Gunakan Pelindungan Pernafasan Wear Mask Protection MS 006	 Gunakan Penutup Rambut Wear Hairnets MS 007
 Gunakan Kasut Keselamatan Wear Footwear Protection MS 008	 Gunakan Sarung Tangan Wear Gloves MS 009	 Gunakan Kot Makmal Wear Lab Coat MS 010	 Gunakan Apron Wear Apron MS 011	 Gunakan Pakaian Cerah Wear Safety Vest MS 012	 Gunakan Abah-Abah Keselamatan Wear Safety Harness MS 013	 Gunakan Pelindung Kimpalan Wear Welding Shield MS 014
 Sila Letak Basikal Di Kawasan Ini Please Parking In This Area MS 015	 Sila Senyap Keep Quiet MS 016	 Angkat Titik Lift Point MS 017	 Sila Laporkan Sebarang Kejadian Yang Telah Berlaku Please Report Accident That Have Occurred MS 018	 Buang Sampah Ke Dalam Tong Sampah Throw All Rubbish Into Bins MS 019	 Susun Dengan Betul Stack Correctly MS 020	 Putuskan Sambungan Utama Disconnect From Main MS 021
 Sila Mendapatkan Kebenaran Sebelum Memulakan Peralatan Keselamatan Kritikal Obtain Authorisation Before Operating Safety Critical Equipment MS 022	 Kunci Sentiasa Keep Lock MS 023	 Gunakan Pakaian Pelindung Wear Protective Clothing MS 024	 Gunakan Pemegang Tangan Use Handrail MS 025	 Basuh Tangan Sebelum Memulakan Kerja Anda Wash Hand Before Starting Your Work MS 026	 Sila Mendapatkan Kebenaran Sebelum Masuk Ruangana Tertutup Obtain Authorisation Before Entering A Confined Space MS 027	 Diagonal Parking MS 028
 Sila Letak Motor Di Kawasan Ini Please Parking In This Area MS 029	 Pasangkan Bonding Wire Use Bonding Wire MS 030	 Sila Laporkan Diri Di Guard House Please Register At Guard House MS 031	 Sila Meindungi Diri Dari Jatuh Apabila Bekerja Di Tempat Tinggi Protect Yourself Against A Fall When Working At Height MS 032	 Sila Letak PPE Anda Di Tempat Yang Disediakan Please Put Your PPE Here MS 033	 Kotak Kunci Keys Box MS 034	 Sila Letak Perkakas Dapur Di Tempat Yang Disediakan Please Put Utensils In The Place Provided MS 035
 Pejalan Kaki Ikut Laluan Ini Pedestrians Must Use This Route MS 036	 Pelindung Mesin Mesti Berada Dalam Keadaan Selamat Sebelum Guna Guards Must Be In Position Before Starting MS 037	 Gunakan Pengawal Keselamatan Use Safety Guards MS 038	 Tutupkan Suis Apabila Tidak Diguna Switch Off When Not In Use MS 039	 Angkat Dengan Betul Lift Correctly MS 040	 Gunakan Tong Sampah Yang Disediakan Use Litter Bins Provided MS 041	 Bunyikan Hon Sound Horn MS 042
 Pakai Tali Pinggang Keledar Wear Safety Belt MS 043	 Gunakan Jambatan Use Footbridge MS 044	 Sila Rujuk Kepada Arahkan Buku Panduan Please Refer To Instruction Manual Booklet MS 045	 Gunakan Pelindung Arc Wear Arc Protection MS 046	 Gunakan Penutup Kasut Wear Shoe Cover MS 047	 Pintu Pagar Automatik Auto Gate MS 048	 Untuk Kenderaan Sahaja For Vehicle Only MS 049
 Sila Hentikan Enjin Kenderaan Anda Please Switch Off Your Engine MS 050	 Gunakan Penyendal Tayar Use Wheel Check MS 051	 Palet Susun Di Sini Pallet stacking MS 052	 Laluan Pejalan Kaki Pedestrian Crossing MS 053	 Sila Nyalakan Lampu Kereta Depan Switch On Headlights MS 054	 Pintu Sentiasa Ditutup Keep Door Closed MS 055	 Gunakan Perindungan Pernafasan Use Respirator MS 056

How To Order ?

STEP : Codes >

Size

300mm (H) x 200mm (W)
400mm (H) x 300mm (W)
600mm (H) x 400mm (W)

Material

THK 1.5mm PVC
THK 3.0mm Aluminium Composite
Self Adhesive Vinyl Sticker



Dilarang Merokok
No Smoking

PS 001



Dilarang Menyalakan Api
No Naked Flame

PS 002



Dilarang Meletak Kenderaan Di Sini
No Parking

PS 003



Dilarang Masuk Ruangan Tertutup
Confined Space

PS 004



Panas Jangan Sentuh
Hot Do Not Touch

PS 005



Jangan Melangkah
Do Not Step

PS 006



Jangan Sentuh
Do Not Touch

PS 007



Dilarang Menggunakan Telefon Bimbit
Do Not Use Mobile Phone

PS 008



Dilarang Bergambar
Photography No Allowed

PS 009



Dilarang Membawa Makanan Dan Minuman Manis
No Food And Sweet Drink Allowed

PS 010



Dilarang Pakai Kasut Selipar
No Slipper

PS 011



Dilarang Minum Arak Sebelum Kerja
No Alcohol Before Working

PS 012



Dilarang Menghalang Pili Bomba Ini
Do Not Block This Fire Hydrant

PS 013



Dilarang Menghalang
Do Not Obstruct

PS 014



Dilarang Menyalahgunakan Dadah
No Drugs

PS 015



Dilarang Berenang
No Swimming

PS 016



Jangan Berdiri Berhampiran Lengan Bergerak
Do Not Stand Near Moving Arm

PS 017



Jangan Menunggang Forklift
Do Not Riding On Forklift

PS 018



Jangan Berada Di Bawah Beban Yang Digantung
Do Not Position Yourself Under A Suspended Load

PS 019



Jangan Menggunakan Tangga
Do Not Use Ladder

PS 020



Dilarang Berlari
Do Not Run

PS 021



Dilarang Menggunakan Lif Semasa Kebakaran
In The Event Of Fire Do Not Use This Lift

PS 022



Dilarang Meletak Motosikal
No Motorcycle Parking

PS 023



Dilarang Meletak Basikal
No Bicycle Parking

PS 024



Dilarang Memakai Barang Perhiasan
Do Not Wear Jewelry

PS 025



Dilarang Masuk Bagi Pesakit Yang Ada Peranti Jantung
Person With Cardiac Pacemakers Cannot Enter

PS 026



Dilarang Membuang Sampah
No Dumping

PS 027



Air Ini Tidak Dibenarkan Minum
Do Not Drink This Water

PS 028



Tanggalkan Kasut Sebelum Masuk
Take Out The Shoes Before Enter

PS 029



Jangan Bercakap
Please Silent

PS 030



Kenderaan Berat Dilarang Masuk
Heavy Vehicle Is Not Allowed To Access

PS 031



Dilarang Memakai Topi Di Dalam Permis Ini
Motorcycle Helmets Are Prohibited Within In Premises

PS 032



Dilarang Buka
Do Not Operate

PS 033



Haiwan Tidak Dibenarkan
No Pet Allowed

PS 034



Dilarang Meludah
Do Not Spit

PS 035



Anjing Tidak Dibenarkan
No Dog

PS 036



Anjing Tidak Dibenarkan Kecuali Anjing Pengawal
No Dog Except Guide Dogs

PS 037



Rendahkan Suara
Lower Down Your Voice

PS 038



Dilarang Mengguna Forklift
Forklift Truck Prohibited

PS 039



Dilarang Mengguna Forklift Tanpa Kebenaran
Operating The Forklift Without Authorization Or Training Is Strictly Prohibition

PS 040



Dilarang Mencangkung Di Atas Mangkuk Tandus Duduk
Do Not Squat On The Siting Toilet Bowl

PS 041



Kawasan Peribadi Dilarang Masuk
Private Property No Trespassing

PS 042



Pejalan Kaki Dilarang Melintas Melalui Pintu Ini
No Pedestrian Crossing Against This Gate

PS 043



Dilarang Melintas
No Thoroughfare

PS 044



Dilarang Masuk
No Access

PS 045



Dilarang Masuk Kecuali Diatih Dan Dapat Kebenaran
No Access Unless Trained And Authorized

PS 046



Dilarang Masuk Tanpa Urusan
No Admission Authorized Personnel Only

PS 047



Dilarang Mengguna Perancah Yang Tidak Lengkap
Do Not Use Scaffold Incomplete

PS 048



Dilarang Baring Di Atas Bangku
Do Not Sleep On Bench

PS 049

How To Order ?

Warning Sign

STEP : Codes >

Size

300mm (H) x 200mm (W)
400mm (H) x 300mm (W)
600mm (H) x 400mm (W)

Material

THK 1.5mm PVC
THK 3.0mm Aluminium Composite
Self Adhesive Vinyl Sticker

How To Order ? Emergency Escape Signs

STEP : Codes >

Size

300mm (H) x 200mm (W)
400mm (H) x 300mm (W)
600mm (H) x 400mm (W)

Material

THK 1.5mm PVC
THK 3.0mm Aluminium Composite
Self Adhesive Vinyl Sticker

H150mm x W300mm

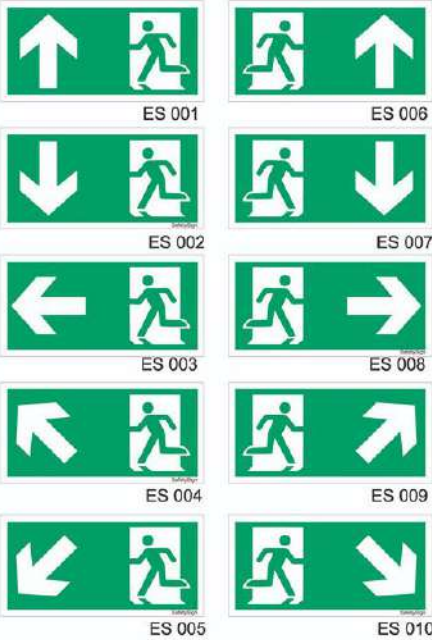

H150mm x W450mm



H150mm x W150mm

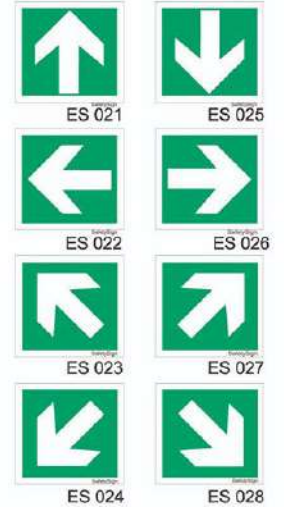

Assembly Point Signs

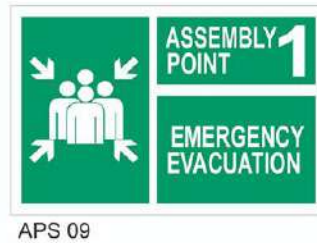

APS 013
3D Assembly Point

How To Order ?

First Aid Signs

STEP : Codes >

Size

Material

THK 1.5mm PVC
THK 3.0mm Aluminium Composite
Self Adhesive Vinyl Sticker

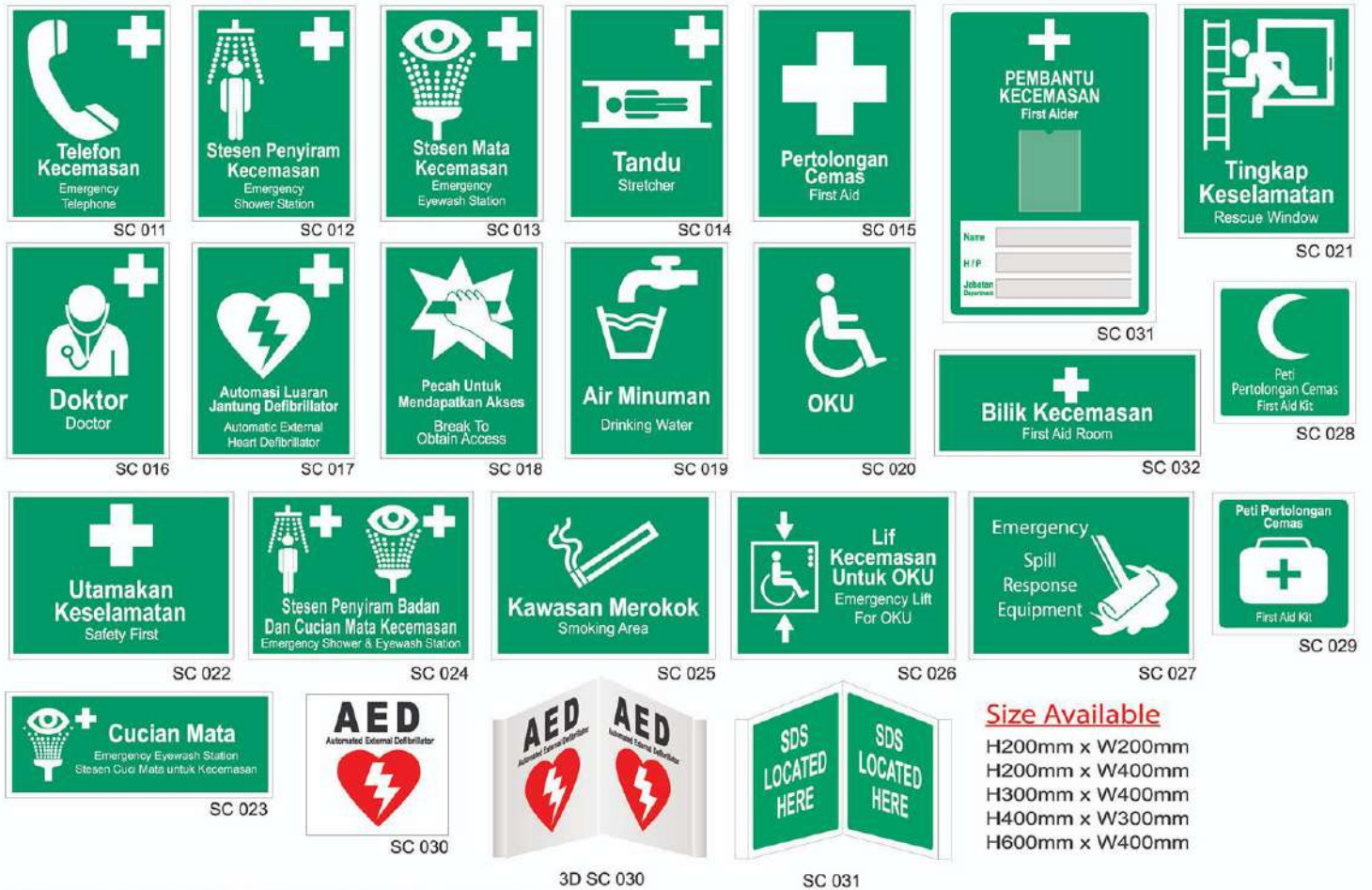

Size Available

- H200mm x W200mm
- H200mm x W400mm
- H300mm x W400mm
- H400mm x W300mm
- H600mm x W400mm

Fire Safety Equipment Signs



How To Order ?

STEP: Codes >

Size >

Material
 THK 1.5mm PVC
 THK 3.0mm Aluminium Composite
 Self Adhesive Vinyl Sticker

Scheduled Waste Sticker



Chemical Storage Signs

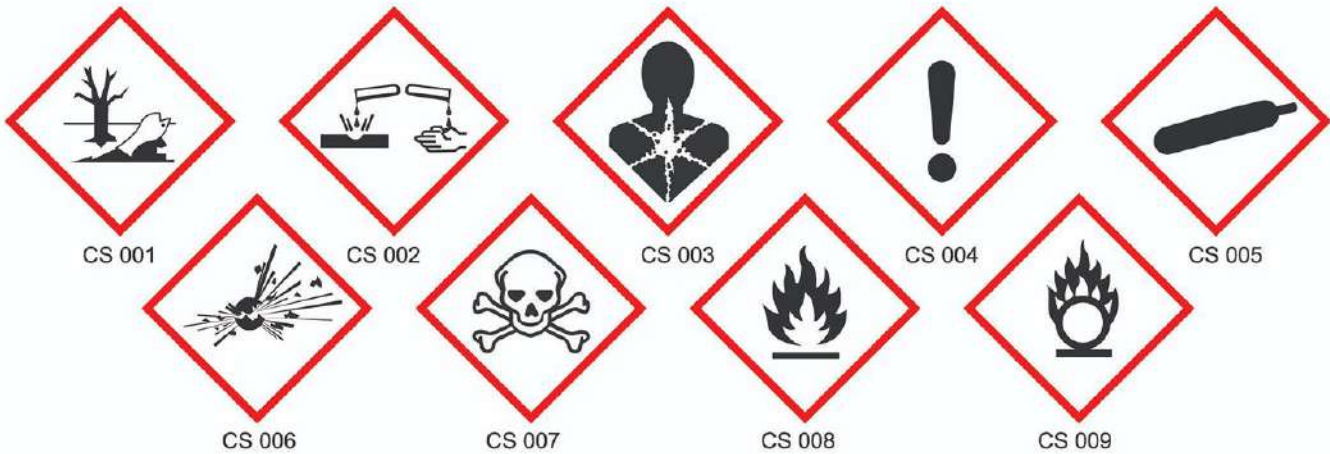

How To Order ?

STEP : Codes >

Size
140mm (H) x 70mm (W)

Material
THK 1.5mm PVC
THK 3.0mm Aluminium Composite
Self Adhesive Vinyl Sticker

Lock-Out Tag-Out Tag

TAG 001: DANGER DILARANG BEROPERASI DO NOT OPERATE
TAG 002: DANGER DIKUNCI LOCKED OUT DILARANG BEROPERASI DO NOT OPERATE
TAG 003: DANGER DIKUNCI LOCKED OUT
TAG 004: DANGER DILARANG BEROPERASI DO NOT OPERATE
TAG 005: DANGER DILARANG PASANGKAN DO NOT START
TAG 006: DANGER DILARANG GUNA DO NOT USE
TAG 007: DANGER DILARANG PASANG SUIS DO NOT SWITCH ON
TAG 008: DANGER DILARANG DO NOT ENERGIZE

TAG 009: DANGER DILARANG TUTUPKAN SUIS DO NOT SWITCH OFF
TAG 010: DANGER DILARANG BUKA INJAP DO NOT OPEN VALVE
TAG 011: DANGER DILARANG TUTUP INJAP DO NOT CLOSE VALVE
TAG 012: DANGER DILARANG BEROPERASI DO NOT OPERATE Maintenance Department
TAG 013: DANGER DILARANG BEROPERASI DO NOT OPERATE Electricians At Work
TAG 014: DANGER DILARANG BEROPERASI DO NOT OPERATE Production
TAG 015: DANGER DILARANG BEROPERASI DO NOT OPERATE (Detailed safety instructions)
TAG 016: DANGER PERMIT SAVE LIFE DO NOT OPERATE

TAG 017: DANGER PERMIT SAVE LIFE DO NOT OPERATE
TAG 018: DANGER DO NOT OPERATE Maintenance Department
TAG 019: DANGER This energy source has been LOCKED OUT!
Back Page 1: Punca kuasa ini sudah di kunci
Back Page 2: DANGER DO NOT REMOVE THIS TAG TAG & LOCK TO BE REMOVED BY PERSON SHOWN ONLY!
Back Page 3: DANGER DO NOT REMOVE THIS TAG DO NOT REMOVE THIS LOCK. IT IS HERE TO PROTECT MY LIFE
TAG 030: DANGER DO NOT USE THIS SCAFFOLD KEEP OFF DO NOT ALTER
TAG 031: STOP UNSAFE FOR USE

TAG 020: DANGER DILARANG PASANG SUIS KERJA SEDIANG DIJALANKAN DO NOT SWITCH ON UNDER MAINTENANCE
TAG 021: DANGER DILARANG TUTUP INJAP DO NOT CLOSE VALVE
TAG 022: DANGER DILARANG BUKA INJAP DO NOT OPEN VALVE
Back Page 4: Punca kuasa ini sudah di kunci
Front - TAG 023: SAFE FOR USE PLATFORM LADDER IDENTIFICATION TAG
Back - TAG 023: INSPECT BY DATE
Front - TAG 024: EMERGENCY SHOWER & EYE WASH TEST RECORD
Back - TAG 024: EMERGENCY SHOWER & EYE WASH TEST RECORD
Front - TAG 025: AWAS RANSANG SCAFFOLD
Back - TAG 025: AWAS RANSANG SCAFFOLD

Sticker Size : H50mm xW50mm

TAG 026: CAUTION UNSAFE
TAG 027: CAUTION OUT OF ORDER
Back Page 5: TAG INI HANYA BOLEH DITANGGAL OLEH:
TAG 028: FIRE EXTINGUISHER INSPECTION RECORD
POWER TOOLS & OTHER'S EQUIPMENT INSPECTION: DATE INSPECTED NEXT INSPECTION
BODY HARNESS INSPECTION: BH S/N: DATE INSPECTED NEXT INSPECTION
LIFTING EQUIPMENT INSPECTION: PMA: DATE INSPECTED
LADDER INSPECTION: S/N: DATE INSPECTED NEXT INSPECTION
GENIE LIFT INSPECTION: S/N: DATE INSPECTED NEXT INSPECTION

How To Order ?

Floor Stand Safety Signs

STEP : Codes >

Size

>

Material

THK 1.5mm PVC
THK 3.0mm Aluminium Composite
Self Adhesive Vinyl Sticker



Stanchions Signs

These Stanchions Signs are the ideal way of displaying signs on a temporary basis.

- Made from steel and painted with grey primer to discourage rusting.
- To hold Stanchion Signs measuring **450 (H) x 600 (W)**, **600(H) x 900(W)**, **750 (H) x 1000(W)**, **800 X 1200 mm**.
- Clips are provided for retaining either two signs into the Double Sided Stanchion or one sign into the Single Sided Stanchion.



How To Order ? Poster Signs

STEP : Codes >

Size Available
H400mm x W300mm
H600mm x W400mm

Material
THK 1.5mm PVC
THK 3.0mm Aluminium Composite
Self Adhesive Vinyl Sticker



POS 001



POS 002



POS 003



POS 004



POS 005



POS 006



POS 007



POS 008

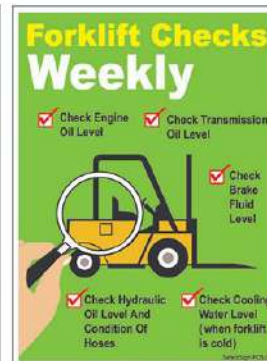

POS 009

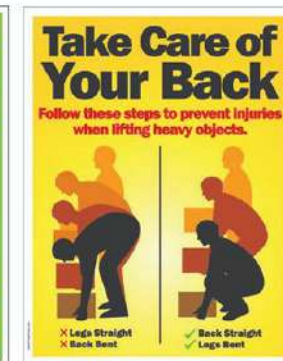

POS 010



POS 011



POS 012



POS 013



POS 014



POS 015



POS 016



POS 017



POS 018

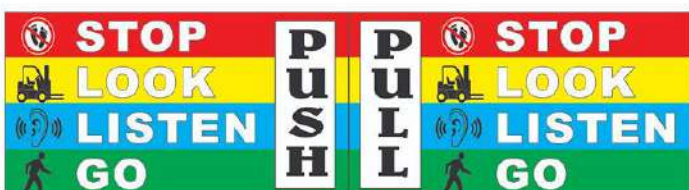

POS 019



POS 020

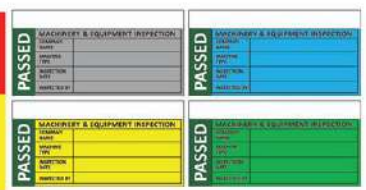

POS 021

How To Order ? Mix And Match

STEP : Codes > **Size** >

Material
THK 1.5mm PVC
THK 3.0mm Aluminium Composite
Self Adhesive Vinyl Sticker

200mm(H) x 600mm(W) COM 127

200mm(H) x 600mm(W) COM 129

400mm(H) x 600mm(W) COM 131

600mm(H) x 400mm(W) COM 132

300mm(H) x 200mm(W) COM 133

200mm(H) x 300mm(W) COM 134

150mm (H) x 400mm (W) COM 135

200mm(H) x 600mm(W) COM 128

200mm(H) x 600mm(W) COM 130

150mm (H) x 400mm (W) COM 136

300mm (H) x 150mm (W) COM 145

200mm (H) x 120mm (W) COM 150

200mm (H) x 120mm (W) COM 151

200mm (H) x 120mm (W) COM 152

200mm(H) x 600mm(W) COM 137

400mm(H) x 600mm(W) COM 141

300mm(H) x 450mm(W) COM 142

300mm (H) x 400mm (W) COM 143

300mm (H) x 150mm (W) COM 145

200mm (H) x 120mm (W) COM 150

200mm(H) x 600mm(W) COM 138

600mm(H) x 400mm(W) COM 146

600mm(H) x 400mm(W) COM 147

600mm(H) x 400mm(W) COM 148

200mm (H) x 45mm (W) COM 149

200mm (H) x 120mm (W) COM 151

200mm(H) x 600mm(W) COM 139

200mm(H) x 600mm(W) COM 140

500mm(H) x 300mm(W) COM 151

500mm(H) x 300mm(W) COM 152

90mm(H) x 600mm(W) COM 153

1300mm (H) x 900mm (W) COM 154

600mm(H) x 400mm(W) COM 155

600mm (H) x 400mm (W) COM 156

600mm (H) x 400mm (W) COM 157

600mm (H) x 400mm (W) COM 158

600mm (H) x 400mm (W) COM 159

600mm (H) x 400mm (W) COM 160

600mm (H) x 400mm (W) COM 161

150mm(H) x 600mm(W) WORKING CUSTOM MADE

600mm (H) x 400mm (W) COM 162

600mm (H) x 400mm (W) COM 163

600mm (H) x 400mm (W) COM 164

300mm (H) x 600mm (W) COM 165

400mm (H) x 600mm (W) COM 166

How To Order ?

Mix And Match

STEP: Codes >

Size >

Material
 THK 1.5mm PVC
 THK 3.0mm Aluminium Composite
 Self Adhesive Vinyl Sticker

UTAMAKAN KESELAMATAN
 SAFETY FIRST

KAWASAN PENSTORAN BUANGAN TERJADUAL
 SCHEDULED WASTE STORAGE AREA

600mm (H) x 1200mm (W) COM 167

PERATURAN MANDATORI
 Anda Selesai Memasuki Zon Pengangkutan Keselamatan

UTAMAKAN KESELAMATAN
 SAFETY FIRST

WEAR SAFETY HELMET
 Gunakan Tool Keselamatan
FALLING OBJECT
KEEP OUT
 Bahaya Operasi Kron
 Sisa Jaminan
DANGER
LIFTING IN PROGRESS
 BAHAYA
 Kerja Mengangkat Sedang Dijalankan

600mm (H) x 1200mm (W) COM 168

UTAMAKAN KESELAMATAN
 SAFETY FIRST

WEAR SAFETY HELMET
 Gunakan Tool Keselamatan
FALLING OBJECT
KEEP OUT
 Bahaya Operasi Kron
 Sisa Jaminan
DANGER
LIFTING IN PROGRESS
 BAHAYA
 Kerja Mengangkat Sedang Dijalankan

600mm (H) x 400mm (W) COM 169

Battery Charging Area
AWAS / DANGER

Bahan Mudah Meletup
 Explosion hazard

Dilarang Merokok
 No Smoking

Dilarang Menyyalakan Api
 No Naked Flame

600mm (H) x 400mm (W) COM 170

UTAMAKAN KESELAMATAN
 SAFETY FIRST

Gunakan Alat-alat Keselamatan Diri Yang Sesuai
 Wear Suitable Personal Protective Equipment

600mm (H) x 1800mm (W) COM 171

UTAMAKAN KESELAMATAN
 SAFETY FIRST

Gunakan Alat-alat Keselamatan Diri Yang Sesuai
 Wear Suitable Personal Protective Equipment

600mm (H) x 1800mm (W) COM 172

KITAR SEMULA
RECYCLE

Fikir dulu sebelum buang / Think before throw

KACA / GLASS
 Sini / Here

KERTAS / PAPER
 Sini / Here

PLASTIK / PLASTIC
 Sini / Here

600mm (H) x 1200mm (W) COM 173

KAWASAN SIMPANAN BAHAN TERJADUAL
 SCHEDULED WASTE STORAGE AREA

SISA BAHAN TOKSIK
 TOXIC SUBSTANCES WASTE

SISA CAECAIR TIDAK MUDAH TERBAKAR
 INFLAMMABLE LIQUIDS WASTE

SISA CAMPURAN PELBAGAI BAHAN BERBAHAYA
 MIXTURE OF MISCELLANEOUS SUBSTANCES

DILARANG MEROKOK
 NO SMOKING

DILARANG MASUK TANPA URUSAN
 NO ADMITTANCE PERSONNEL ONLY

750mm (H) x 1350mm (W) COM 174

UTAMAKAN KESELAMATAN
 SAFETY FIRST

CYLINDER AREA

600mm (H) x 1600mm (W) COM 175

UTAMAKAN KESELAMATAN
 SAFETY FIRST

WWTP

BAHAYA DANGER Bahan Kimia Toksik / Toxic

BAHAYA DANGER Bahan Kimia Merengsa / Irritant Chemical

BAHAYA DANGER Bahan Menghakis / Corrosive Chemical

AWAS Trak Forklift
 CAUTION Forklift

Dilarang Masuk Tanpa Urusan / No Access For Unauthorized Persons

Gunakan Pelindung Mata / Wear Eye Protection

Gunakan Pelindung Pernafasan / Wear Mask Protection

Gunakan Pelindung Muka / Wear Face Shield

Gunakan Sarung Tangan / Wear Gloves

Gunakan Apron / Wear Apron

Gunakan Kasut Keselamatan / Wear Footwear Protection

Gunakan Pakaian Pelindung / Wear Protective Clothing

600mm (H) x 1500mm (W) COM 176

PPE REQUIREMENT IN OPERATIONS AREA

Gunakan Tool Keselamatan dengan Teliti / Wear Safety Helmet with Care Only

Gunakan Pelindung Mata / Wear Eye Protection

Gunakan Pelindung Telinga / Wear Ear Protection

Gunakan Pelindung Perut / Wear Mouth Protection

Gunakan Sarung Tangan / Wear Gloves

Gunakan Pelindung Lengan / Wear Arm Guards

Gunakan Kasut Keselamatan / Wear Footwear Protection

Utah Pelment / Pelment / Pelment / Pelment

SAFETY RULES

Dilarang Menggunakan Telefon Bimbit / Do Not Use Mobile Phone

AWAS Trak Forklift / CAUTION Forklift

BAHAYA Bahan Mengangkat Sedang Dijalankan / DANGER Lifting in Progress

Jangan Berada Di Samping / Do Not Stand / Do Not Stand / Do Not Stand

1100mm (H) x 1200mm (W) COM 177

UTAMAKAN KESELAMATAN
 SAFETY FIRST

Sila ikut Peraturan Keselamatan / Follow All Safety Instructions Provided

1100mm (H) x 1200mm (W) COM 178

LPG STORE

Gas Mudah Terbakar / Flammable Gas

Gas Di Bawah Tekanan / Gas Under Pressure

Dilarang Merokok / No Smoking

Dilarang Menyyalakan Api / No Naked Flame

Dilarang Menggunakan Telefon Bimbit / Do Not Use Mobile Phone

BAHAYA / DANGER Bahan Mudah Terbakar / Flammable Material

Pintu Sentiasa Ditutup / Keep Door Close

Double Stacking Sahaja Dibenarkan / Allow Double Stacking Only

300mm (H) x 600mm (W) COM 179

UTAMAKAN KESELAMATAN
 SAFETY FIRST

QA CHEMICAL ROOM

BAHAYA DANGER Bahan Kimia Toksik / Toxic

BAHAYA DANGER Bahan Mudah Terbakar / Flammable Material

BAHAYA DANGER Bahan Menghakis / Corrosive Chemical

BAHAYA DANGER Bahan Kimia Merengsa / Irritant Gas

BAHAYA DANGER Bahan Aspirasi / Respiratory Sensitization

BAHAYA DANGER Berbahaya Kepada Alam Sekitar / Hazardous To The Environment

Dilarang Masuk Tanpa Urusan / No Access For Unauthorized Persons

Gunakan Pelindung Mata / Wear Eye Protection

Gunakan Pelindung Pernafasan / Wear Mask Protection

Gunakan Pelindung Muka / Wear Face Shield

Gunakan Sarung Tangan / Wear Gloves

Gunakan Apron / Wear Apron

Gunakan Kasut Keselamatan / Wear Footwear Protection

600mm (H) x 1500mm (W) COM 187

Jangan Berlari / Do Not Run

Dilarang Menggunakan Telefon Bimbit / Do Not Use Mobile Phone

Gunakan Pemegang Tangan / Please Use Handrail

Watch Your Step

Jangan Letakan Tangan Dalam Saku / Do Not Hand In Pocket

Jangan Letakan Tangan Dalam Saku / Do Not Hand In Pocket

80mm (H) x 600mm (W) COM 180

80mm (H) x 400mm (W) COM 181

LP GAS STORE

Bahaya Terbakar / Flammable

Gas Tertempat / Gas Under Pressure

Dilarang Merokok / No Smoking

Dilarang Menyyalakan Api / No Naked Flame

Dilarang Menggunakan Telefon Bimbit / Do Not Use Mobile Phone

BAHAYA Bahan Mudah Terbakar / Flammable Material

300mm (H) x 600mm (W) COM 182

Jangan Berlari / Do Not Run

Dilarang Menggunakan Telefon Bimbit / Do Not Use Mobile Phone

Gunakan Pemegang Tangan / Please Use Handrail

Awasi Langkah Anda / Watch Your Step

80mm (H) x 1200mm (W) COM 183

BERHENTI / STOP
MELIHAT / LOOK
MENDENGAR / LISTEN
JALAN / GO

Dilarang Bermain Telefon Bimbit Semasa Berjalan / Do Not Play Phone While Walking

RECYCLE MIXED PAPER ONLY

RECYCLE MIXED PLASTIC ONLY

23 inch (H) x 7.5 inch (W) COM 184

600mm(H) x 400mm(W) COM 185

600mm(H) x 400mm(W) COM 186

How To Order ? Mix And Match

STEP : Codes >

Size >

Material

THK 1.5mm PVC
THK 3.0mm Aluminium Composite
Self Adhesive Vinyl Sticker

UTAMAKAN KESELAMATAN
பாதுகாப்பு முதன்மை

Bahan Mengakis
Corrosive

Bahan Kimia Merengsa
Harmful Irritant

Bahan Toksik
Toxic

600mm (H) x 400mm (W) COM 188

UTAMAKAN KESELAMATAN
பாதுகாப்பு முதன்மை

Gunakan Pelindung Mata
Wear Eye Protection

Gunakan Pelindung Telinga
Wear Ear Protection

Gunakan Kasut Keselamatan
Wear Footwear Protection

Gunakan Pakaian Cerah
Wear Safety Vest

600mm (H) x 600mm (W) COM 189

Parking area for motorcycle & bicycle

400mm (H) x 600mm (W)
aCOM 190

PERHATIHAN
LET STONES
DURING
PAVING
WORKING
IN PROGRESS

600mm (H) x 300mm (W)
COM 191

MAIN OFFICE

CAFETERIA

MALE
SURAU & LOCKER ROOM

FEMALE
SURAU & LOCKER ROOM

300 (H) x 200mm (W) COM 192

SW 306
Spent Hydraulic Oil

SW 307
Spent Mineral Oil Emulsion

300 (H) x 200mm (W) COM 193

SW 410
Rags, Plastics, Papers or Filters Contaminated With Scheduled Waste

SW 429
Chemicals that are discarded or off-specification

TOXIC SUBSTANCES (WASTE)

Fluorescent Tube
(SW 109)

TOXIC SUBSTANCES (WASTE)

Used Mixed Container
(SW 409)

TOXIC SUBSTANCES (WASTE)

E-waste
(SW 110)

TOXIC SUBSTANCES (WASTE)

Used Oily Rags Of Glove
(SW 410)

FLAMMABLE LIQUIDS (WASTE)

Spent Lubricating Oil
(SW 305)

FLAMMABLE LIQUIDS (WASTE)

Ink Waste
(SW 417)

300 (H) x 200mm (W) COM 194

Gunakan Kasut Keselamatan Dari Tempat Sini
Wear Foot Protection Beyond This Point

18 inch (H) x 22 inch (W) COM 195

REVERSED PARKING

600mm (H) x 400mm (W) COM 196

DENDA PENALTY
Untuk Kesalahan Tidak Memakai Peralatan Keselamatan
For Offenses of Not Wearing Safety Equipment

RM 50.00 RM 50.00 RM 50.00

300 (H) x 900mm (W) COM 197

DENDA PENALTY
Untuk Kesalahan Tidak Memakai Peralatan Keselamatan
For Offenses of Not Wearing Safety Equipment

RM 50.00 RM 50.00 RM 50.00 RM 50.00

300 (H) x 900mm (W) COM 198

AWAS / CAUTION
KENDERAAN BERGERAK
BEWARE OF MOVING VEHICLES

10 km/h

24 inch (H) x 96 inch (W) COM 201

CAUTION! LOW PIPE SUPPORT

100 (H) x 1050mm (W) COM 202

PERSON IN CHARGE

NAME CONTACT NO.

300 (H) x 400mm (W) COM 199

SILA PASTIKAN LUKA ANDA DIBALUT SEBELUM MASUK KE KAWASAN INI

PLEASE MAKE SURE YOUR WOUND BE PLASTER BEFORE ENTER TO THIS AREA

400mm (H) x 300mm (W) COM 200

Gunakan Alat-Alat Keselamatan Yang Sesuai
Wear Suitable Protective Equipment

Gunakan pelindung mata
Wear eye protection

Gunakan penutup rambut
Wear hairnet

Ket makmal mesti dipakai di kawasan ini
Lab coats must be worn in this area

Gunakan kasut keselamatan
Wear protective footwear

600 (H) x 400mm (W) COM 203

Gunakan Alat-Alat Keselamatan Yang Sesuai
Wear Suitable Protective Equipment

Gunakan topi keselamatan
Wear safety helmets

Gunakan pelindung mata
Wear eye protection

Gunakan penutup rambut
Wear hairnet

Gunakan kasut keselamatan
Wear protective footwear

600 (H) x 400mm (W) COM 204

Gunakan Alat-Alat Keselamatan Yang Sesuai
Wear Suitable Protective Equipment

Gunakan topi keselamatan
Wear safety helmets

Gunakan pelitup gas
Wear respirator

Gunakan sarung tangan
Wear gloves

Gunakan kasut keselamatan
Wear protective footwear

600 (H) x 400mm (W) COM 205

How To Order ?

STEP : Codes >

Size

>

Material

THK 1.5mm PVC
THK 3.0mm Aluminium Composite
Self Adhesive Vinyl Sticker

Glow In The Dark Floor Markers

Provide additional directional information to strengthen your safety way guidance system.



Footprints
Sheet Size:
250 x 350mm
Footprint size:
238 x 104mm
Code: FMT01



75mm Dia
FMT1AL



75mm Arrow
FMT2AL



100 x 100mm
FMT3AL



Marking exit doors



40mm x 5m (Right / Left) - MED04L(R/L)



40mm x 5m (Right / Left) - MED06L2 (R/L)



40mm x 5m (Right / Left) - MED04L3(R/L)



40mm x 5m - MED04L-P



40mm x 5m - MED04LGrn



40mm x 5m - MED04LYelw



40mm x 5m - MED04LBlk

Floor Marking Tape & 5S Labelling

Floor marking tape can be used to mark your facility's aisles, walkways, safety hazards, storage areas and more. Floor tape is available in continuous rolls, corner marks (L, T and cross shapes). Aisle and floor marking tapes are made of heavy duty polyester or vinyl that resists oil, moisture. The marking tape will stick to virtually any dry surface when applied.



Arrow

Size Available - 50x120	76x203	100x250mm
- Yellow : 5S-002-YLW	5S-0021-YLW	5S-0022-YLW
- Green : 5S-002-GRN	5S-0021-GRN	5S-0022-GRN
- Black : 5S-002-BLK	5S-0021-BLK	5S-0022-BLK
- Red : 5S-002-RED	5S-0021-RED	5S-0022-RED
- Blue : 5S-002-BLUE	5S-0021-BLUE	5S-0022-BLUE

Packaging : 20 pcs / Pkt



"+" Marks

Size Available - 50x120	76x203	100x250mm
- Yellow : 5S-003-YLW	5S-0031-YLW	5S-0032-YLW
- Green : 5S-003-GRN	5S-0031-GRN	5S-0032-GRN
- Black : 5S-003-BLK	5S-0031-BLK	5S-0032-BLK
- Red : 5S-003-RED	5S-0031-RED	5S-0032-RED
- Blue : 5S-003-BLUE	5S-0031-BLUE	5S-0032-BLUE

Packaging : 20 pcs / Pkt



"L" Marks

Size Available - 50x120	76x203	100x250mm
- Yellow : 5S-005-YLW	5S-0051-YLW	5S-0052-YLW
- Green : 5S-005-GRN	5S-0051-GRN	5S-0052-GRN
- Black : 5S-005-BLK	5S-0051-BLK	5S-0052-BLK
- Red : 5S-005-RED	5S-0051-RED	5S-0052-RED
- Blue : 5S-005-BLUE	5S-0051-BLUE	5S-0052-BLUE

Packaging : 20 pcs / Pkt



"T" Marks

Size Available - 50 x 120mm	
Yellow : 5S-004-YLW	Red : 5S-004-RED
Green : 5S-004-GRN	Blue : 5S-004-BLUE
Black : 5S-004-BLK	Packaging : 20pcs / Pkt



Footprint

Size Available - 250 x 90mm	
Yellow : 5S-006-YLW	Red : 5S-006-RED
Green : 5S-006-GRN	Blue : 5S-006-BLUE
Black : 5S-006-BLK	Packaging : 20 Pairs / Pkt



Circle

Size Available - Dia 90mm	
Yellow : 5S-001-YLW	Red : 5S-001-RED
Green : 5S-001-GRN	Blue : 5S-001-BLUE
Black : 5S-001-BLK	Packaging : 20 Pcs / Roll

Labelling



Anti Slip Hazard Tape

Size Available - 2" x 60 Feet
3" x 60 Feet
6" x 60 Feet
6" x 24"



Anti Slip Tape

Size Available - 50mm x 18m



Barricade Tape

Size Available -
- 72mm x 50m - 144mm x 200m
- 72mm x 100m - 720mm x 200m
- 72mm x 200m



Acrylic Foam Tape

Size Available -
- 10mm x 9y - 18mm x 9y
- 12mm x 9y - 24mm x 9y



Floor Marking Tape

Size Available -
- 24mm x 33y - 60mm x 33y
- 36mm x 33y - 72mm x 33y
- 48mm x 33y

475GP

GLOVE DESIGNED FOR OIL, GAS, MINING AND INDUSTRIAL USE. GREAT OVERALL FIT/ PERFORMANCE/PROTECTION FOR BUDGET PRICING.

-  3D Curved Fingers
-  High Visibility
-  2-way stretch fabric
-  HyPrene Hi Breathable / quick dry cuff
-  Extreme Dry Grip
-  Reinforced Thumb Crotch
-  7MM High Anti-impact metacarpal protection
-  Impact Foam
-  7MM High TPR finger protection

Additional Features

- Double layered palm
- Molded fit
- Sizes XS-XXXL

PASSENFEN 13594 6.8.2
IMPACT ENERGY ATTENUATION

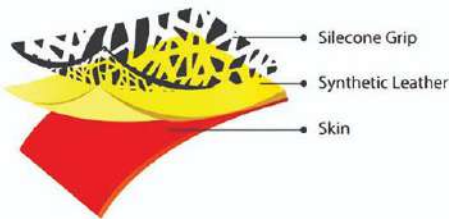

EN388:
4232



510GP

BUILD ON THE GP500 PLATFORM WITH AMAX-5 TECHNOLOGY FOR ENVIRONMENTS WHERE HIGHER CUT AND PUNCTURE RESISTANCE IS REQUIRED. THE AMAX-5 TECHNOLOGY DOESN'T HAVE AN IMPACT ON THE FIT OR THE DEXTERITY OF THE GLOVE.

-  Level 5 Cut Resistance
-  7MM High TPR knuckle protection
-  Water repellent
-  3D Curved Fingers
-  High Visibility
-  Impact Foam
-  Extreme Dry Grip
-  HyPrene Hi Breathable / quick dry cuff
-  Kevlar Stitching
-  4-way Stretch Fabric
-  Reinforced Thumb Crotch
-  7MM High Anti-impact metacarpal protection
-  Oil Repellent
-  7MM High TPR finger protection

Additional Features

- Nitrile fabric between the fingers
- Double layered palm
- Molded fit
- Sizes XS-XXXL

PASSENFEN 13594 6.8.2
IMPACT ENERGY ATTENUATION



EN388:
4232



FIBREGLASS PLATFORM STEP LADDERS

150KG RATED | AS 1892



NON-CONDUCTIVE
SAFE FOR ELECTRICAL WORK

FIBREGLASS PREMIUM RANGE

- UV RESISTANT FIBREGLASS - lasts longer and better value
- Safest failsafe platform (500kg Load test)
- Double gusset braces and Strongbow full base brace systems
- Stronger RHS rear frame
- Swagelock step connection 50% stronger
- Strongest plated foot connection
- Lightweight

OPTIONS

- SAFETY GATE
- PLATFORM KICKBOARD
- CASTOR KIT



POWER-MAX
ULTIMATE ELECTRICAL FAILSAFE



NON-CONDUCTIVE
SAFE FOR ELECTRICAL WORK

FIBREGLASS STANDARD RANGE

- UV RESISTANT FIBREGLASS - lasts longer and better value
- Safest failsafe platform (500kg Load test)
- Stronger full gusset base brace - "GUSSET GUTZ"
- Channel section rear frame
- Swagelock step connection 50% stronger
- Strongest plated foot connection
- Lightweight

OPTIONS

- SAFETY GATE
- PLATFORM KICKBOARD
- CASTOR KIT



POWER-MAX
ULTIMATE ELECTRICAL FAILSAFE



CODE	PLATFORM HEIGHT (m)	WIDTH (mm)	WEIGHT (kg)	BASE BRACE	TRANSPORT CUBE (m ³)
FPS5-2	.61	580	11	Gusset	.33
FPS6-3	.88	620	12	Gusset	.39
FPS7-4	1.17	660	13	Gusset	.45
FPS8-5	1.45	700	14	Gusset	.51
FPS9-6	1.74	740	15	Gusset	.57
FPS10-7	2.02	780	16	Strongbow	.63
FPS11-8	2.30	820	17	Strongbow	.69
FPS13-10	2.89	1050	26	Strongbow	1.22

CODE	PLATFORM HEIGHT (m)	WIDTH (mm)	WEIGHT (kg)	TRANSPORT CUBE (m ³)
FPS5-2G	.61	580	11	.21
FPS6-3G	.88	620	12	.26
FPS7-4G	1.17	660	13	.32
FPS8-5G	1.45	700	14	.39
FPS9-6G	1.74	740	15	.46

All measurements are nominal and do not indicate "exact weights and measures"

AUSTRALIA'S LADDER SPECIALIST

LADaMAX PRODUCT CATALOGUE | 5



ALUMINIUM PLATFORM STEP LADDERS

150KG RATED | AS 1892

ALUMINIUM PREMIUM RANGE

- Safest failsafe platform (500kg load test)
- Double gusset braces and Strongbow full base brace systems
- Stronger RHS rear frame
- Swagelock step connection 50% stronger
- Strongest plated foot connection

OPTIONS

- SAFETY GATE
- PLATFORM KICKBOARD
- CASTOR KIT



ALUMINIUM STANDARD RANGE

- Safest failsafe platform (500kg Load test)
- Stronger full gusset base brace - "GUSSET GUTZ"
- Channel section rear frame
- Swagelock step connection 50% stronger
- Strongest plated foot connection

OPTIONS

- SAFETY GATE
- PLATFORM KICKBOARD
- CASTOR KIT



CODE	PLATFORM HEIGHT (m)	WIDTH (mm)	WEIGHT (kg)	BASE BRACE	TRANSPORT CUBE (m ³)
PS5-2	.61	580	9	Gusset	.33
PS6-3	.88	620	10	Gusset	.39
PS7-4	1.17	660	11	Gusset	.45
PS8-5	1.45	700	12	Gusset	.51
PS9-6	1.74	740	13	Gusset	.57
PS10-7	2.02	780	14	Strongbow	.63
PS11-8	2.30	820	15	Strongbow	.69
PS13-10	2.89	860	24	Strongbow	1.22
PS15-12	3.45	1050	26	Strongbow	1.4

CODE	PLATFORM HEIGHT (m)	WIDTH (mm)	WEIGHT (kg)	TRANSPORT CUBE (m ³)
PS5-2G	.61	580	9	.33
PS6-3G	.88	620	10	.39
PS7-4G	1.17	660	11	.45
PS8-5G	1.45	700	12	.51
PS9-6G	1.74	740	13	.57

All measurements are nominal and do not indicate "exact weights and measures"

6 | PRODUCT CATALOGUE LADaMAX

WWW.LADAMAX.COM.AU

MOBILE ORDER PICKER WAREHOUSE RANGE

150KG RATED | AS 1892



ALUMINIUM

- Safest failsafe platform (500kg Load test)
- World's safest aluminium platform
- Complete mobility castors
- Safety integrated hand rail
- Double gusset braces up to and including 6'ft platform height



OPTIONS



SAFETY GATE



PLATFORM KICKBOARD

CODE	PLATFORM HEIGHT (m)	WIDTH (mm)	WEIGHT (kg)	TRANSPORT CUBE (m ³)
SM5-2	.61	580	12.5	.33
SM6-3	.88	620	14	.39
SM7-4	1.17	660	15	.45
SM8-5	1.45	700	16	.51
SM9-6	1.74	740	17	.57
SM10-7	2.02	780	19	.63
SM11-8	2.30	820	20	.69

NON-CONDUCTIVE SAFE FOR ELECTRICAL WORK

FIBREGLASS

- UV RESISTANT FIBREGLASS - lasts longer and better value
- Safest failsafe platform (500kg Load test)
- World's safest aluminium platform
- Complete mobility castors
- Safety integrated hand rail
- Double gusset braces up to and including 6'ft platform height



OPTIONS



SAFETY GATE



PLATFORM KICKBOARD

CODE	PLATFORM HEIGHT (m)	WIDTH (mm)	WEIGHT (kg)	TRANSPORT CUBE (m ³)
FSM5-2	.61	580	11	.33
FSM6-3	.88	620	12	.39
FSM7-4	1.17	660	13	.45
FSM8-5	1.45	700	14	.51
FSM9-6	1.74	740	15	.57
FSM10-7	2.02	780	16	.63
FSM11-8	2.30	820	17	.69

All measurements are nominal and do not indicate 'exact weights and measures'

AUSTRALIA'S LADDER SPECIALIST

LADaMAX PRODUCT CATALOGUE | 7



STEP LADDERS SINGLE SIDED

150KG RATED | AS 1892

ALUMINIUM

- Swagelock step connection 50% stronger
- Stronger full gusset base brace - "GUSSET GUTZ"
- Side arm locks
- Strongest foot connection
- Lightweight



CODE	LENGTH (m)	WIDTH (mm)	WEIGHT (kg)	TRANSPORT CUBE (m ³)
SS042	1.20	470	5	0.07
SS052	1.80	545	7	0.12
SS082	2.40	620	9	0.19
SS102	3.00	695	14	0.26
SS122	3.60	770	16	0.35

NON-CONDUCTIVE SAFE FOR ELECTRICAL WORK

FIBREGLASS

- UV RESISTANT FIBREGLASS - lasts longer and better value
- Swagelock step connection 50% stronger
- Stronger full gusset base brace - "GUSSET GUTZ"
- Side arm locks
- Strongest plated foot connection
- Lightweight



CODE	LENGTH (m)	WIDTH (mm)	WEIGHT (kg)	TRANSPORT CUBE (m ³)
FSS042	1.20	470	5	0.17
FSS062	1.80	545	11	0.21
FSS082	2.40	620	15	0.26
FSS102	3.00	695	19	0.36
FSS122	3.60	770	23	0.49

All measurements are nominal and do not indicate 'exact weights and measures'

8 | PRODUCT CATALOGUE LADaMAX

WWW.LADAMAX.COM.AU

STEP LADDERS DOUBLE SIDED

150KG RATED | AS 1892



ALUMINIUM

- Swagelock step connection 50% stronger
- Stronger full gusset base brace - "GUSSET GUTZ"
- Side arm locks
- Strongest foot connection
- Lightweight



CODE	LENGTH (m)	WIDTH (mm)	WEIGHT (kg)	TRANSPORT CUBE (m ³)
DS032	.90	435	7	0.07
DS042	1.20	470	8	0.1
DS062	1.80	545	10	0.17
DS082	2.40	620	13	0.26
DS102HA	3.00	695	20	.36
DS122HA	3.60	770	22	0.49
DS142HA	4.20	845	32	0.62
DS162HA	4.80	920	40	0.77

NON-CONDUCTIVE SAFE FOR ELECTRICAL WORK

FIBREGLASS

- UV RESISTANT FIBREGLASS - lasts longer and better value
- Swagelock step connection 50% stronger
- Stronger full gusset base brace - "GUSSET GUTZ"
- Side arm locks
- Strongest plated foot connection
- Lightweight



CODE	LENGTH (m)	WIDTH (mm)	WEIGHT (kg)	TRANSPORT CUBE (m ³)
FDS032	.90	435	6	0.07
FDS042	1.20	470	8	0.1
FDS062	1.80	545	12	0.17
FDS082	2.40	620	16	0.26
FDS102	3.00	695	22	0.36
FDS122	3.60	770	26	0.49

All measurements are nominal and do not indicate 'exact weights and measures'

AUSTRALIA'S LADDER SPECIALIST

LADaMAX PRODUCT CATALOGUE | 9



EXTENSION LADDERS

150KG RATED | AS 1892

ALUMINIUM EXTENSION LADDERS

- Interlocking side rails for safety and stability
- Strongest flat top 'D' rung
- Easy flow rope system
- Large flat feet
- Swagelock 'D' rung connection stronger
- Braided rope
- Lightweight



CODE	LENGTH (m)	WIDTH (mm)	WEIGHT (kg)	TRANSPORT CUBE (m ³)
XT082	2.4/3.9	420	14	0.14
XT102	3.0/5.1	420	17	0.18
XT122	3.6/6.3	420	20	0.22
XT132	3.9/6.9	420	22	0.23
XT142	4.2/7.5	420	23	0.25
XT162	4.8/8.4	420	27	0.29
XT182	5.4/9.6	420	31	0.32
XT202	6.0/10.8	420	33	0.36

All measurements are nominal and do not indicate 'exact weights and measures'

NON-CONDUCTIVE SAFE FOR ELECTRICAL WORK

FIBREGLASS EXTENSION LADDERS

- Purpose designed for electrical contractors
- Rung replacement system available
- Easy slide acetel blocks
- Easy flow braided rope system
- UV inhibitors
- Interlocking side rails for safety, rigidity and stability
- Strongest flat top 'D' rung
- Large solid ladder boots - for extra support
- Upper section is free of rope
- Pole chain as standard
- Lightweight



CODE	LENGTH (m)	WIDTH (mm)	WEIGHT (kg)	TRANSPORT CUBE (m ³)
FX1082	2.7/3.9	390/405	17	0.18
FXT102	3.3/5.1	390/405	20	0.22
FXT122	3.9/6.3	390/405	25	0.25
FXT142	4.5/7.5	390/405	28	0.29
FXT162	5.1/8.5	390/405	31	0.34

10 | PRODUCT CATALOGUE LADaMAX

WWW.LADAMAX.COM.AU

NEXUS HEIGHTMASTER

Our pioneering helmet combines an advanced high performance liner for improved impact with modern recreational styling - including a replaceable 4-point adjustable EN 12492 chinstrap.

ATTRIBUTES

- High performance liner provides extra shock and penetration protection according to EN 12492
- Easily replaceable chinstrap for improved hygiene
- Chinstrap side adjusters for improved wearer fit and comfort
- Polyester webbing ensures that it doesn't catch on workwear Velcro



STANDARD



OPTIONAL



APPROVED TO

[EN 12492]
[ANSI/ISEA] Class C | LT
[AS/NZS 1801]

CONFORMS TO

[EN 50365]
[EN 397] LD | -40°C
(In respect of shock and penetration)



SAFEST

High performance liner inside



Product Codes: S16E*FMR (Wheel Ratchet Vented) / S30NL (Nexus Liner) / S30NY (EN 12492 Chinstrap)
*Insert colour of helmet (i.e. W for White)

SPECTRUM SECURE PLUS

ABS safety helmet system with integrated over spectacles to deliver grade B EN 166 impact protection and ANSI/ISEA Z87+. Also suitable for wearers of prescription eyewear.

ATTRIBUTES

- Eyewear provides extra lateral and bottom coverage and provides extra protection against particles
- Anti-scratch and anti-mist coating on eyewear provides improved durability and visibility
- Soft nose bridge for enhanced wearer comfort
- Full over spectacle adjustment built in to ensure the user can obtain a perfect fit
- NEW Spectrum with badge holder available



STANDARD



OPTIONAL



HELMET APPROVED TO

[EN 397] LD | MM | -40°C
[EN 50365]

VENTED

[ANSI/ISEA] Class C | LT

UNVENTED

[EN 397] 1000V.e.c
[ANSI/ISEA] Class E | LT
[CAN/CSA] Z94.1-05

OVER SPECTACLES APPROVED TO

[EN 166] 1 | B | T
[EN 170] 2C-1.2
[ANSI/ISEA] Z87+
[CAN/CSA] Z94.3-07

SAFER/SAFE*

Over spectacles with Grade B impact protect

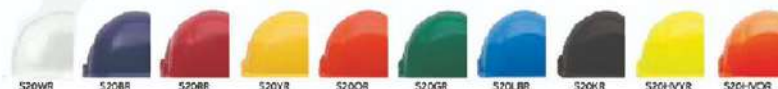

Product Codes: S20*R (Wheel Ratchet) / S20*RL (SecurePlus Wheel Ratchet) / S20*RF (Vented Wheel Ratchet) / S20*RLF (SecurePlus Vented) / S575 (Spare Over Spectacles) / S576SE (Spare Smoke Over Spectacles) For Spectrum Badge Holder add SBH to product code
*Insert colour of helmet (i.e. W for White)

VISION SECURE PLUS

Our industry-leading head protection system offers wearers of prescription glasses total safety reassurance with moulded integrated eye protection uniquely certified to EN 166 grade A high impact levels and ANSI/ISEA Z87+.

ATTRIBUTES

- Optical clarity to Class 1 for continuous use - standard on all Centurion face protection
- Grade A High Energy Impact Protection to EN 166: providing the highest impact protection possible within EN 166 - better than any other integrated eyewear on the market
- Large side pull tabs enable the wearer to quickly and easily move the visor up and down even when wearing gloves
- Includes anti-scratch and anti-mist coating for improved durability and visibility



Product Codes: S10PLUSEWA (Slip Ratchet) / S10PLUSEBA (Wheel Ratchet) / S10PLUSECA (SecurePlus Wheel Ratchet) / S577 (Spare clear visor)
*Insert colour of helmet (i.e. W for White)

STANDARD



OPTIONAL



HELMET APPROVED TO

[EN 397] 1000V a.c | LD | MM | -40°C
 [ANSI/ISEA] Class E | LT

VISOR APPROVED TO

[EN 166] 1 | A | T
 [EN 170] 2C-1,2
 [ANSI/ISEA] Z87+

SAFER/SAFE*

Grade A impact protection

NEXUS SECURE PLUS

Our multi award winning helmet combines advanced industrial safety standards with modern recreational styling including a 4-point chinstrap for added stability, security and comfort.

ATTRIBUTES

- SecurePlus 4-point quick release chinstrap for added stability and comfort
- Chinstrap side adjusters for improved wearer fit and comfort
- Micro peak for maximum upward visibility
- Polyester webbing ensures that it doesn't catch on workwear Velcro

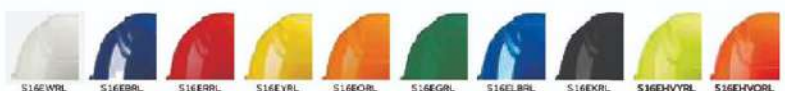

Product Codes: S16E*RL (Wheel Ratchet) / S16E*L (Slip Ratchet) / S16E*RLF (Wheel Ratchet, Vented) / S16E*LF (Slip Ratchet, Vented)
*Insert colour of helmet (i.e. W for White)

STANDARD



OPTIONAL



APPROVED TO

[EN 397] LD | MM | -40°C
 [EN 50365]
 [AS/NZS 1801]

UNVENTED

[EN 397] 1000V a.c
 [ANSI/ISEA] Class E | LT | -40°C
 [CSA/CAN] Class E

VENTED

[ANSI/ISEA] Class C | LT | -40°C
 [CSA/CAN] Class C



SAFER

4-point chinstrap for increased stability

CONCEPT SECURE PLUS

High safety with low weight. Reassuring strength with feel-good comfort.

ATTRIBUTES

- Complete with 4 point SecurePlus EN 397 quick release chinstrap
- High performance ABS shell allows for optimal strength to weight ratio
- Internal card holder for identification or medical information
- **NEW** Concept Badge Holder version available



SAFER

4-point chinstrap for increased stability



Product Codes: S08C*L (Slip Ratchet) / S08C*RL (Wheel Ratchet) / S08C*LF (Slip Ratchet, Vented) S08C*LRF (Wheel Ratchet, Vented) For Concept Badge Holder add CBH to product code
*Insert colour of helmet i.e. W for White

STANDARD



OPTIONAL



APPROVED TO

[EN 397] LD | MM | -40°C
[EN 50365]

UNVENTED

[EN 397] 1000V a.c
[ANSI/ISEA] Class E

VENTED

[ANSI/ISEA] Class C

NEXUS CORE

Our multi award winning helmet combines advanced industrial safety standards with modern recreational styling.

ATTRIBUTES

- Modularity as standard. Simply by adding accessories, you can have one helmet style on site, with accessories to support different tasks
- High performance ABS material and creative design enables -40°C low temperature performance, lateral deformation and optimal strength to weight ratio allows for a strong, protective helmet
- Optimised micro peak providing maximum upward visibility
- Dry-Tech Sweatband for maximum comfort, for extended periods of use



SAFE
Style with substance



Product Codes: S16E*A (Slip Ratchet) / S16E*F (Slip Ratchet, Vented) / S16E*R (Wheel Ratchet) / S16E*RF (Wheel Ratchet, Vented)
* Insert colour of helmet i.e. W for White

STANDARD



OPTIONAL



APPROVED TO

[EN 397] LD | MM | -40°C
[EN 50365]
[AS/NZS 1801:]

VENTED

[ANSI/ISEA] Class C | LT | -40°C
[CSA/CAN] Class C

UNVENTED

[EN 397] 1000V a.c
[ANSI/ISEA] Class E | LT | -40°C
[CAN/CSA] Class E



CONCEPT

High safety with low weight. Reassuring strength with feel-good comfort. Our Concept is the helmet that tore up the rule-book.

ATTRIBUTES

- Manufactured from high quality, strong ABS material
- High performance ABS shell allows for optimal strength to weight ratio
- Unique extended nape ensures enhanced neck protection
- Dry-Tech Sweatband for maximum comfort, for extended periods of use
- NEW Concept Badge Holder version available



Product Codes: S09C*A (Full Peak, Slip Ratchet) / S09C*F (Full Peak, Slip Ratchet, Vented) / S08C*A (Reduced Peak, Slip Ratchet) / S08C*F (Reduced Peak, Vented Slip Ratchet) / S09C*R (Full Peak, Wheel Ratchet) / S09C*RF (Full Peak, Wheel Ratchet, Vented) / S08C*R (Reduced Peak, Wheel Ratchet) / S08C*RF (Reduced Peak, Wheel Ratchet, Vented) For Concept Badge Holder add CBH to product code
*Insert colour of helmet (i.e. W for White)

STANDARD



OPTIONAL



APPROVED TO

[EN 397] LD | MM | -40°C
[EN 50365]

VENTED

[ANSI/ISEA] Class C
[AS/NZS 1801] Class C

UNVENTED

[EN 397] 1000V a.c
[ANSI/ISEA] Class E

SAFE

Up to 20% Lighter*

1125 CLASSIC

Our general purpose safety helmet comes with a 6-point Terylene cradle and brushed nylon sweatband.

ATTRIBUTES

- Reduced or Full Peak available

STANDARD



APPROVED TO

[EN 397] 1000V a.c (unvented shell only) | MM | -30°C
[ANSI/ISEA] Z89.1-2014 Type 1 Class E (unvented shell only)

Product Codes: S03C*A (Full Peak Non Vented) / S03E*F (Full Peak Vented) / S17*A (Reduced Peak Non Vented)
*Insert colour of helmet (i.e. W for White)



SAFE

Even Centurions entry helmets have 6 point cradles

REFLEX

For day-long comfort, our Reflex Safety Helmet offers a 6-point Nylon cradle, brushed nylon sweatband and ventilation – all as standard.

ATTRIBUTES

- Designed with safety in mind; supplied with a Silver rear Flash as standard. Also available with a Bright Yellow or Orange rear Flash

STANDARD



APPROVED TO

[EN 397] MM | -30°C
[EN 50365]



Product Codes: S12*SA (for Silver flash) / S12*HV*A (for Bright Yellow or Orange flash) / S12H*V*A (for Bright Yellow or Orange complete helmet) / S12*SR (for Silver flash with Wheel Ratchet) / S12*HV*R (for Bright Yellow or Orange flash with Wheel Ratchet) / S12H*R (for Bright Yellow or Orange complete helmet with Wheel Ratchet)
*Insert colour of helmet (i.e. W for White) - see colour strip

1100 CLASSIC

Our general purpose safety helmet is fitted with a 6-point plastic cradle.

STANDARD



APPROVED TO

[EN 397] 440V a.c (unvented shell only) | MM | -10°C



Product Codes: S01C*A Full Peak Slip Non-Vented / S01C*C Full Peak Slip Non-Vented with Brushed Nylon Sweatband / S01E*F Full Peak Slip Vented / S01E*FC Full Peak Slip Vented with Brushed Nylon Sweatband
*Insert colour of helmet (i.e. W for White)

NEXUS HIGH HEAT

Our **NEW** specialised Glass Filled Nylon safety helmet is designed to protect workers where there is a risk from high levels of radiant heat.

ATTRIBUTES

- Glass Filled Nylon shell which resistant to radiant temperatures of up to 150°C
- Optimised micro peak providing maximum upward visibility
- Comfortable fit with Terylene 6-Point Cradle and Vabon Sweatband
- Fully adjustable wheel ratchet for a custom fit
- Fully removable EN 397 2 point Optional leather chinstrap



Modern styling resistant to radiant temperatures



Product Codes: S22PLUS***R** (Ratchet)
*insert colour of helmet (i.e. W for White)

STANDARD



OPTIONAL



APPROVED TO

[EN 397] 440V a.c | LD | MM | -10°C | +150°C | LD
| 2000V a.c.
[ANSI/ISEA] Z89.1-2014 Type 1 Class G (2200V ac)



NEW High heat carrier available see page 25 for more information

CONTOUR FACE PROTECTION

CONTOUR XIII

CLEAR-GREY HT (HIGHLY TRANSPARENT) ARC FACE SCREEN

Utilises the latest Arc technology; the clearest European Class 2 screen with the highest Visible Light Transmittance providing improved colour recognition for the user.

ATTRIBUTES

- Specialised nano particles technology providing Class 2 arc protection highest Visible Light Transmittance Class 0 (>80%)
- Permanent Anti-Fog and Anti scratch coating
- Longer in use life of 10 years with permanently attached Chinguard

STANDARD



APPROVED TO

[EN 166] 1 | B | 8 | 3
[EN 170] 2C-1.2
[Arc Class 2 GS-ET-29]



NEW Easy fit, Clearest Arc Class 2 approved face protection

Product Codes: S830 Contour XIII Clear-Grey HT Face Screen / S25WR830 Kit consisting of Nexus Helmet with Wheel Ratchet and Arc Class 2 Clear-Grey HT Screen fitted to Contour Carrier



NEW Easy fit, Arc Class 2 approved face protection

CONTOUR XII

LIGHT-GREEN ARC FACE SCREEN

Provides an effective Class 2 face protection solution.

ATTRIBUTES

- Specialised nano particles technology providing Class 2 arc protection
- Visible Light Transmittance Class 0 (>75%)
- 5 years in use lifetime with integrated Grey Nylon Chinguard

STANDARD



APPROVED TO

[EN 166] 1 | B | 8 | 3
[EN 170] 2C-1.2
[Arc Class 2 GS-ET-29]

Product Codes: S820 Contour XII Light-Green Face Screen / S25WR820 Kit consisting of Nexus Helmet with Wheel Ratchet and Arc Class 2 Light-Green Screen fitted to Contour Carrier

NEW AIRPRO SECURE PLUS BUMP CAP

Our flagship baseball bump cap designed to provide unrivalled head retention and wearer comfort. The first ever baseball bump cap to incorporate a ratchet adjustment system.

ATTRIBUTES

- Innovative new ratchet adjustment
- Crown ventilation for increased cooling
- Treated with Dupont Teflon for easy cleaning and improved hygiene
- Liner manufactured from ABS for optimal strength
- Peak options available: Full (50mm), Reduced (30mm)
- Side Scoops available (MOQ 500 units)

NEW Up to 50% better head retention and stability*



STANDARD



OPTIONAL



APPROVED TO
[EN812] -40°C

CENTURION



Product Codes: S38* (Standard Peak, 50mm) / S38*RP (Reduced Peak, 30mm)
*Insert Colour code of cap i.e. NB for Navy Blue / ** Additional colours, side scoops and peak lengths are available subject to MOQ's. Please contact sales for more information.

AIRPRO BUMP CAP

Our bump cap has been designed for maximum breathability, maximum comfort and minimum weight, with approval to EN 812.

ATTRIBUTES

- Designed to provide maximum breathability for increased coolness
- One of the lightest Bump caps around at only 135g
- Treated with Dupont® Teflon® fabric protector, enabling small spills and grime to be easily wiped away
- Peak options available: Full (50mm), Reduced (30mm), Micro (15mm)
- Side Scoops available (MOQ 500 units)

Providing comfort, safety and style



STANDARD



OPTIONAL



APPROVED TO
[EN812] -40°C



Product Codes: S38* (Standard Peak, 50mm) / S38*RP (Reduced Peak, 30mm) / S38NPS (Micro Peak - Navy Blue) / S38NVS (Reduced Peak with Side Scoops for Ear Defender Compatibility - Navy Blue)

*Insert Colour code of cap i.e. NB for Navy Blue / ** Additional colours, side scoops and peak lengths are available subject to MOQ's. Please contact sales for more information.

COOL CAP BUMP CAP

Our fashion-led CoolCap combines high ventilation, high flexibility and reassuring protection against minor bumps and scrapes to the head.

ATTRIBUTES

- Cap is fitted over an ABS liner to provide lightweight head protection
- Corporate badging via embroidery or transfer print

STANDARD



APPROVED TO
[EN812] -40°C

OPTIONAL



Product Codes: S28* (Standard Peak, 50mm) / S28NBRP (Reduced Peak, 30mm - Navy Blue only)
*Insert Colour code of cap i.e. NB for Navy Blue



High performance ABS liner



Velcro strap for easy adjustment

CAP 2000 BUMP CAP

Our robust CAP 2000 offers reassuring protection against minor bumps and scrapes to the head.

ATTRIBUTES

- Traditional panel baseball bump cap with ventilation mesh grills
- Complete with full 360° ABS liner

STANDARD



APPROVED TO
[EN812] -40°C

OPTIONAL



Product Code: S18* (Standard Peak, 60mm)
*Insert Colour code of cap i.e. NB for Navy Blue

CONTOUR XI

MULTI PURPOSE MOULDED FACE SCREEN

Designed to protect against EN 166 medium energy impact and Class 1 Arc Flash risks posed by electrical faults.

ATTRIBUTES

- Polycarbonate moulded screen for both impact protection and Arc protection
- Anti-Fog and Anti scratch coating
- Integrated Chinguard

STANDARD



APPROVED TO

[EN 166] 1 | B | T | 8 | 9 | 3
[EN 170] 2C-1,2
[ANSI/ISEA] Z87.1+
[Arc Class 1 GS-ET-29]

Product Codes: S810 Contour XI Multi Purpose Face Screen / S25WCONTAE Kit consisting of Nexus Helmet with Wheel Ratchet and Multi Purpose / Arc Class 1 Screen fitted to Contour Carrier



Easy fit, Arc Class 1 approved face protection



CONTOUR X

GENERAL PURPOSE MOULDED FACE SCREEN ATTRIBUTES

- Polycarbonate moulded screen for medium energy impact protection

APPROVED TO

[EN 166] 1 | B | T | 9 | 3
[EN 170] 2C-1,2
[ANSI/ISEA] Z87.1+

Easy fit, general purpose face protection

Product Codes: S800 Contour X General Purpose Face screen

CONTOUR CARRIER

GENERAL PURPOSE CONTOUR CARRIER ATTRIBUTES

- Low profile, pivoting system follows helmet contour
- Unique TPE rubber collar is fitted as standard to help block falling debris
- Multi pivot functionality for maximum versatility
- Contour clips for fitting to Nexus and Concept helmets

APPROVED TO

[EN 166]
[ANSI/ISEA] Z87.1+

Product Codes: S55 Contour Face Screen Carrier



Easy fit, low profile system

CLASSIC FACE PROTECTION

CLASSIC FACE SCREENS

General Purpose face screens available in polycarbonate for medium energy impact protection, acetate for chemical resistance or acetate green for welding.

- All face screens can be used with both the Classic Carrier and the Classic headband mounted Browguard

Product Codes: General Purpose Face Screens: S580 - Polycarbonate 150mm / S590 - Polycarbonate 210mm / S591 - Acetate Clear 210mm / S592 - Acetate Antifog 210mm Face Screens for Chinguard: S910 - Polycarbonate / S911 - Acetate Clear / S912 - Acetate Antifog



CLASSIC CARRIER

A carrier for fitting helmet mounted face screens. For fitting Classic face screens to all Centurion helmets.

Product Codes: S54CE Carrier / S54TCE Carrier - fitted with thumbscrews



CLASSIC BROWGUARD

Classic Browguard for fitting Classic face screens when head protection is not required.

Product Code: S89 Browguard



CLASSIC CHINGUARD

Chinguard for fitting to Chinguard Face Screens for additional coverage.

Product Code: S91C Chinguard



FORESTRY VISOR

In the unique forestry environment, our visor offers a high degree of face protection without restricting the vision of the wearer. The visor is pre-mounted onto a Centurion carrier for total protection against falling debris and for stability during use.

- Forestry Kit available, see page 15 for further information

Product Codes: S59CE - Forestry Visor / S25CCOOF - Forestry Kit with Concept Orange Vented Helmet and Scala X Ear Defenders

HIGH HEAT FACE PROTECTION & ACCESSORIES



NEW HIGH TEMPERATURE PREMIUM FACE SCREEN CARRIER

In conjunction with the high temperature classic face screens, a complete high temperature face system designed to supply specialist protection in areas at risk of radiant heat. Suitable for use on Nexus high heat and Vulcan helmets. Made from steel aluminium with black anodised coating.

Product Codes: S58 - Premium Carrier for Nexus High Heat and Vulcan helmet



HIGH TEMPERATURE CLASSIC FACE SCREEN CARRIER

In conjunction with the high temperature classic face screens, a complete screen and carrier face system designed to supply specialist protection in areas at risk of radiant heat. Suitable for use on Nexus high heat and Vulcan helmets.

Product Codes: S57CE - Carrier for Nexus High Heat and Vulcan helmet / S57TCE - Carrier fitted with thumbscrews



HIGH TEMPERATURE CLASSIC FACE SCREENS

High Temperature face screens available for high temperature applications.

- To be used with Premium or Classic High Temperature Face Screen Carriers

Product Codes: High Temperature face screens: S598 - Triacetate Clear / S760 - Gold Polycarbonate



2 POINT EN 397 LEATHER CHINSTRAP

Specifically designed to complement the Nexus High Heat helmet, a leather chin strap to cope with high temperature environments.

Product Code: S30L - Nexus High Heat helmet / S30V - Vulcan helmet



HIGH TEMPERATURE ALUMINISED NECK CAPE

Complementing the Nexus High Heat and Vulcan helmets, this aluminised Neck Cape ensures maximum heat dissipation from the wearer.

Product Code: S36

HEARING PROTECTION & VISIBILITY



SCALA XI EAR DEFENDERS

Designed and approved to fit all Centurion helmets. Excellent noise protection, especially for high frequencies. SNR 30 dB.

- Available to fit Euro, Connect or Combi slot helmets

Product Codes: S72CE



SCALA X EAR DEFENDERS

A helmet mounted ear defender system to complement all Centurion safety helmets. Suitable for most general requirements. SNR 25 dB.

- Available to fit Euro, Connect or Combi slot helmets

Product Codes: S71CE



HIGH INTENSITY REFLECTIVE STICKERS

Making the safe, safer. A set of high intensity, highly reflective accessory stickers, bespoke for the Centurion range of safety helmets. Helps to increase visibility of workers in low light level environments meeting material specification of EN 12899-1 Ra2.

- Provides coverage on front, side, rear and top of the helmet
- Sticker sets for the Nexus helmet - available in 6 colours
- Sticker set for Reflex, Concept, Vision Plus and Spectrum helmets in Silver

Product Codes: Nexus: S30*NHIRS

Spectrum, Vision Plus, Concept and Reflex: S30HIRS (* Insert colour of stickers)

COLOUR VARIATIONS



CHINSTRAPS & MOUNTING

Global data and our own analysis highlighted changes in the market with chinstrap usage becoming more specified in growing regions such as Scandinavia and Asia. Working at height is also a rapidly growing market segment, and so too are the injuries that result from this environment. We strongly believe chinstraps should be fitted on industrial safety helmets – whether on or above ground. They provide added helmet retention / security and help workers shaping our world deliver their best.



4 POINT EN 12492 CHINSTRAP

Designed specifically for the demanding Nexus HeightMaster helmet, a replacement chinstrap to ensure EN 12492 compliance.

- Grey in colour to differentiate workers on site from EN 397 chinstraps

Product Code: S30NY



2 POINT EN 397 ELASTICATED CHINSTRAP

2 point elasticated chinstrap to complement the Centurion range of helmets, fully approved to EN 397. Fitted with chin cup for extra comfort

- Black in colour to identify chinstrap as an EN 397 chinstrap

Product Code: S30E



4 POINT EN 397 SECURE PLUS CHINSTRAP

Ergonomically designed chinstrap conforming to EN 397. Fitted to all SecurePlus helmet variants.

- Black in colour to differentiate workers on site from EN 12492 chinstraps

Product Codes: S30LY



HELMET ACCESSORY CLIPS - CONNECT, EURO AND CONTOUR

Accessory clips to allow the fitment of hearing and face protection products.

- Connect and Euro clips can be used on Centurion helmets with Combi slots (1100, 1125, Reflex, Concept and Spectrums)
- Connect clips can be used on Vulcan and 1125 Reduced Peak helmets
- Euro clips can be used on Nexus and Vision Plus helmets
- Contour clips can be used on Nexus and Concept helmets

Product Codes: Connect Accessory Clips S570 / Euro Accessory Clips S565 / Contour Accessory Clips S585

COOLING SYSTEMS

KALIS DRY COOLING ACCESSORIES

The **NEW** patent-pending Dry Cooling technology is designed to provide enhanced cooling comfort for the wearer. The Kalis dry cooling system is shown to keep the wearer 15°C/27°F cooler than ambient temperature and completely dry. It keeps the wearer cooler for up to 4 times longer compared to wet cooling products.

ATTRIBUTES

- Keeps the wearer 15°C (27°F) cooler than the ambient temperature
- Up to 5 times longer in use life*
- 100% dry
- Anti-bacterial and machine washable
- Utilises technology found in the high end sports industry

STANDARD



TESTED** TO
[EN 397]
[ANSI/ISEA]

[CSA/CAN] Nexus Core and Secure Plus with ratchet only

[AS/NZS 1801:] Nexus Core and Secure Plus with ratchet only

Product Codes: S31DCHP Helmet Pad / S31DCHS All Seasons Sweatband Management Kit



NEW Up to 4x longer cooling*

In Partnership with:



SUN CAPES

Lightweight Sun Cape that protects against UltraViolet UPF 50+, blocks 98% of UV radiation. Using fabric developed specifically to keep the wearer dry, cool and comfortable.

ATTRIBUTES

- Available in Bright Yellow or Orange
- Fits to all Centurion helmets

Product Codes: S51HVY Sun Cape Bright Yellow / S51HVO Sun Cape Bright Orange

CONCEPT AIR FLIP UP VISOR KIT

Complete Respiratory Protection system with lightweight Flip up Polycarbonate visor -maximising all round vision and head coverage.

NEW AND IMPROVED
Battery up to 25% lighter*



ATTRIBUTES

- 200 litres of filtered air per minute
- **NEW** lightweight Li-ion batteries, with a typical 8 hour usage before recharge
- Complete with a TH2PSL particulate filter and 5 Pre Filters

STANDARD



APPROVED TO

EN 12941 TH2P

EN 166 1 | B | 9 | 3

CONCEPT AIR WELDING SHIELD KIT

Versatile ready to use welding respiratory protection system, complete with high performance Auto-Darkening welding filter and storage box.

NEW AND IMPROVED
Battery up to 25% lighter*



ATTRIBUTES

- 200 litres of filtered air per minute
- High Performance Welding Shield with grinding mode
- Lightweight Li-ion battery, with 8 hour duration
- Complete with a TH2PSL particulate filter and 5 pre-filters

STANDARD



APPROVED TO

[EN 12941] TH2P

ADF LENS APPROVED TO

[EN 379] Class 1.1.1.1

WELDING SHIELD APPROVED TO

[EN 175] TH2P

Product Codes: ConceptAir Kit - R23AWH9/13KIT **Component Codes:** Headpiece - R23AWH9/13 / ConceptAir 2000 Plus - R23/2000PLUS / Filter - R23P2/5 / Pre Filters - R23PF/10 / Battery - R23BLI / Battery Charger - R23BCLI / Headpiece Hose - R23HAHD

NEW NEVIS UNPOWERED FRESH AIR (FABA) SYSTEM

Unpowered Fresh Air Breathing Apparatus system suitable for use in Oxygen deficient atmospheres, including confined spaces and potentially explosive environments for short duration work

ATTRIBUTES

- Lightweight Full-Face Mask – excellent vision with an excellent fit
- 9m hose supplied in storage box
- Can be used with hose lengths up to 20m

STANDARD



APPROVED TO

[EN 138] Class 2

Product Codes: R26/400S (Small) R26/400M (Medium) R26/400L (Large) **Component codes:** R08NFF - Full Face Mask (S/M/L) / R26TAH - Twin Air Hose / R26/003P - Belt with hose connector / R269MH - 9 Metre Breathing Hose / R26SA - Strainer and Anchor pin assembly / R26/005 - Storage Box / M08SC3BAG - Mask Storage Bag **Optional Hose Lengths:** R26/20 - 20m Breathing Hose



NEW and IMPROVED
Modern, lightweight Full Face mask available in 3 sizes - with twin hose connection

NEW NEVIS POWERED FRESH AIR (FABA) SYSTEM

Powered Fresh Air Breathing Apparatus system. Air is supplied from an electrical supplied blower system for longer duration work.

ATTRIBUTES

- Up to 500L/min of supplied fresh air
- Lightweight Full-Face Mask – excellent vision with an excellent fit
- 9m hose supplied in storage box
- Can be used by 1 or 2 users up to 40m

STANDARD



APPROVED TO

[EN 138] Class 2

Product Codes: R26/500S (Small) R26/500M (Medium) R26/400L (Large) **Component codes:** R08NFF - Full Face Mask (S/M/L) / R26TAH - Twin Air Hose / R26/003P - Belt with hose connector / R269MH - 9 Metre Breathing Hose / R26SA - Strainer and Anchor pin assembly / R26/005 - Storage Box / M08SC3BAG - Mask Storage Bag / R26LWT110 - Mini-turbine 110v **Optional Hose Lengths:** R26/20 - 20m Breathing Hose / R26/30 - 30m Breathing Hose / R26/40 - 40m Breathing Hose **Optional Mini-turbines:** R26LWT240 - Mini-turbine 240v (UK or EU)



NEW and IMPROVED
Modern, lightweight Full Face mask available in 3 sizes - with twin hose connection

Eyewashes



Quickly rinse contaminants from eyes.

- GS-Plus™ spray heads deliver water for effective flushing.
- 11-1/2" diameter ABS plastic or stainless steel (SS) bowl.
- Wall mount with included bracket or floor mount with included pedestal and floor flange.
- ANSI-compliant sign included.
- Units are assembled and water tested prior to shipment.

DESCRIPTION	MODEL
Eyewash, Wall Mounted, Plastic Bowl	G1814P
Eyewash, Wall Mounted, SS Bowl	G1814
Eyewash, Wall Mounted, SS Bowl with Cover	G1814BC
Eyewash, Pedestal Mounted, Plastic Bowl	G1825P
Eyewash, Pedestal Mounted, SS Bowl	G1825
Eyewash, Pedestal Mounted, SS Bowl with Cover	G1825BC
Eyewash, Wall Mounted, All-SS	G1891

Eye/Face Washes



Quickly rinse contaminants from eyes and face.

- Extra large FS-Plus™ spray heads deliver more water in a larger spray pattern for facial coverage.
- 11-1/2" diameter ABS plastic or stainless steel (SS) bowl.
- Wall mount with included bracket or floor mount with included pedestal and floor flange.
- ANSI-compliant sign included.
- Units are assembled and water tested prior to shipment.

DESCRIPTION	MODEL
Eye/Face Wash, Wall Mounted, Plastic Bowl	G1750P
Eye/Face Wash, Wall Mounted, SS Bowl	G1750
Eye/Face Wash, Wall Mounted, SS Bowl with Cover	G1750BC
Eye/Face Wash, Pedestal Mounted, Plastic Bowl	G1760P
Eye/Face Wash, Pedestal Mounted, SS Bowl	G1760
Eye/Face Wash, Pedestal Mounted, SS Bowl with Cover	G1760BC

Emergency Showers



Quickly wash away contaminants with full body flush.

- 10" diameter ABS plastic or stainless steel (SS) shower head.
- Galvanized pipe and fittings. All stainless steel (All-SS) for corrosive environments.
- Accommodate common water supply pipe location with horizontal or vertical mounted units.
- ANSI-compliant sign included.

DESCRIPTION	MODEL
Emergency Shower, Vertically Mounted	G1635
Emergency Shower, Vertically Mounted, SS Head	G1635SSH
Emergency Shower, Horizontally Mounted	G1643
Emergency Shower, Horizontally Mounted, SS Head	G1643SSH
Emergency Shower, Horizontally Mounted, All-SS	G1691

Safety Stations



Combination eye or eye/face wash and shower station quickly washes contaminants from eyes, face and body.

- 10" diameter ABS plastic or stainless steel (All-SS) shower head.
- 11-1/2" diameter ABS plastic eye or eye/face wash bowl. stainless steel (SS) bowl for high traffic environments. Stainless steel bowl with cover (SS Bowl with Cover) for added spray head protection.
- Galvanized pipe and fittings. All stainless steel (All-SS) models for corrosive and high traffic environments.
- ANSI-compliant sign included.
- Eye and eye/face wash assemblies are water tested prior to shipment.

DESCRIPTION	MODEL
Safety Station with Eyewash, Plastic Bowl	G1902P
Safety Station with Eyewash, SS Bowl	G1902
Safety Station with Eyewash, SS Bowl with Cover	G1902BC
Safety Station with Eye/Face Wash, Plastic Bowl	G1950P
Safety Station with Eye/Face Wash, SS Bowl	G1950
Safety Station with Eyewash, SS Bowl with Cover	G1950BC
Safety Station with Eyewash, All-SS	
Safety Station with Eye/Face Wash, All-SS	G1991
Alarm for Safety Station	G1996

AP275-200

Portable Eyewashes

Quickly wash contaminants from eyes in low traffic areas, or where continuous supply of potable water is unavailable for plumbed units.

- Fill tanks with potable water and included G1540BA bacteriostatic additive. Replace water and additive every six months to ensure bacteria-free eyewash.
- G1562 includes eyewash and drench hose. Stainless steel pressurized tank is ideal for floor placement near any hazard or can be mounted on stainless steel dolly.
- G1540 gravity fed polyethylene unit includes eyewash only. Unit is wall mountable with included steel bracket.
- G1562HTR and G1540HTR heated units are ideal for cold weather environments down to -20°F.
- ANSI-compliant sign included.
- Units are assembled and water tested prior to shipment.

DESCRIPTION	MODEL
Portable Eyewash/Drench Hose Unit, 15 gallon	G1562
Portable Eyewash/Drench Hose Unit, 15 gallon with Heater and Insulation Jacket	G1562HTR
Dolly for Portable Eyewash/Drench Hose Unit	G1562DLY
Hand Cart for Portable Eyewash/Drench Hose Unit	G1562HC
Portable Eyewash, Gravity-Fed, 16 gallon	G1540
Portable Eyewash, Gravity-Fed, 16 gallon with Heater and Insulation Jacket	G1540HTR
Bacteriostatic Additive, Replacement	G1540BA



Faucet Mounted Eyewashes

Add-on eyewash allows faucet to be used as faucet or eyewash.

- Pull knob activates eyewash. Unit operates until knob is pushed back to original position.
- EyeSafe™ spray head outlets mount 3" apart to fit most faucets.
- EyeSafe-X™ large profile spray head outlets mount 5" apart to fit gooseneck faucets.
- G1200 and G1201 offer single motion activation with Faucet Control Valve. Faucet remains 'on' at preset temperature and flow of water is controlled by valve. Pull knob activates eyewash at any time regardless of control valve position.
- Units are assembled and water tested prior to shipment.

DESCRIPTION	MODEL
Faucet Mounted Eyewash, EyeSafe™ 3" spray head	G1100
Faucet Mounted Eyewash, EyeSafe-X™ 5" spray head	G1101
Faucet Mounted Eyewash, EyeSafe™ 3" spray head with Faucet Control Valve	G1200
Faucet Mounted Eyewash, EyeSafe-X™ 5" spray head with Faucet Control Valve	G1201

G1100
Faucet Mounted
Eyewash, EyeSafe™
3" spray head



G1201
Faucet Mounted
Eyewash, EyeSafe-X™
5" spray head with
Faucet Control Valve



Cryogenic Loading Arm

It is suitable for transferring liquified gas at very low temperature, such as liquid natural gas, etc.

The swivel joints at cryogenic loading arm are designed with two-flanges structure, and make it easily replace the primary and secondary seals. The nitrogen purging system make the ball trace dry preventing the entry of atmospheric moisture. The swivel joints are manufactured by numerically controlled machines, specially designed seal makes the joint resistant to very low temperature.

The swivel joints and pipelines material are stainless steel grade 316L, and are welded according to special procedure and treated by special process. After strict inspection and test, we guarantee that every arm has excellent function performances.

1. Places applied: bottom close loading and unloading
2. Application: cryogenic ethylene, LNG, etc
3. Nominal Diameter: DN50-DN100
4. Material: pipeline-SS, swivel joints-SS, structure componets-CS
5. Design Temperature: -196°C to 100°C
6. Design Pressure: -0.06MPa-2.0MPa

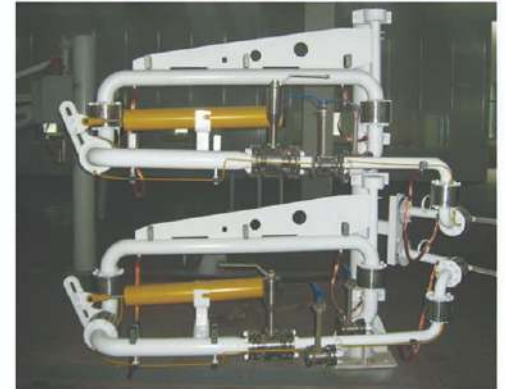

Folding Stairs for Tankers

Folding stairs is specially designed to provide safe and efficient means of access between a loading platform and road or rail tankers.

Folding Stairs Features:

1. Fully balanced self-leveling Steps to automatically adjust to varying tanker heights.
2. Safety handrails and knee guards fitted as standard.
3. Hinged safety step to protect against accidentally trapping toes.
4. Pull-rope to assist returning stairs to "parked" position.
5. Vertical locking device for "parked" position with foot-peal release.
6. Extended outboard step to provide additional area and stability, for stepping onto the tanker top.
7. Rubber bumper to prevent sparking and reduce risk of tanker damage.

Applications:

Safe access from fixed platforms to the top of a Road Tanker, Rail Tank Wagon, or ISO Container to:

1. Inspect the tanker for safety and maintenance
2. Load the tanker
3. Check the load and take samples
4. Wash or decontaminate compartment

Benefits:

1. Safe, reliable and easy means of tanker access
2. Maintenance free spring cylinder and rotation joints
3. Fulfils current Health & Safety at Work requirements and promotes safe working practice on tanker tops

Specification:

1. Balancing type: spring cylinder
2. Operation mode: manual
3. Material: carbon steel



Folding Stairs

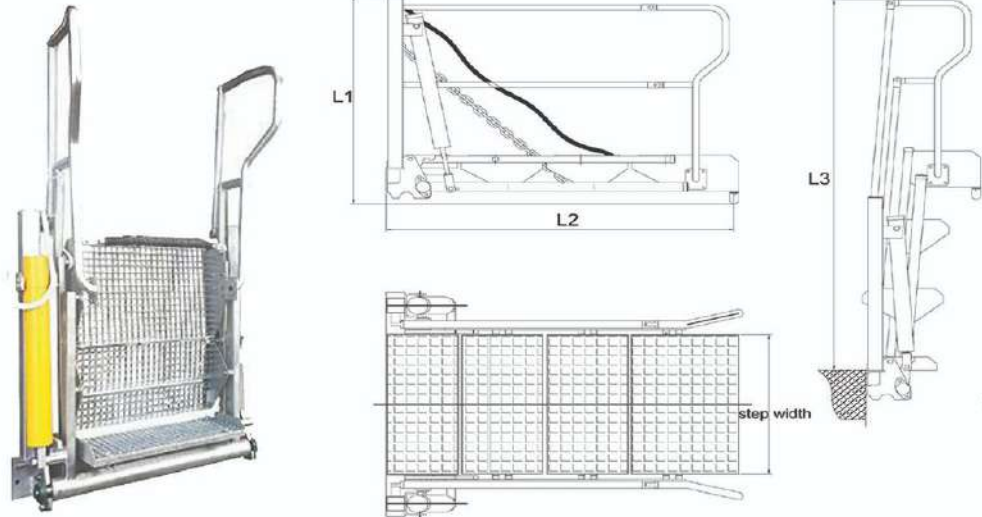

Model	Steps	Step Width (mm)	L1 (mm)	L2 (mm)	L3 (mm)	Rail Size (mm)	Weight (kgs)
KTS-A	3	800	1210	1250	1820	/	195
KTS-B	3	800	1210	1250	1820	1400*1400	220
KTS-C	3	600	1210	1250	1820	/	115
KTM-A	4	800	1210	1650	2150	/	245
KTM-B	4	800	1210	1650	2150	1400*1400	260
KTM-C	4	600	1210	1650	2150	/	137
KTL-A	5	800	1210	2050	2550	/	270
KTL-B	5	800	1210	2050	2550	1400*1400	295
KTL-C	5	600	1210	2050	2550	/	165

Loading Platform

Loading platform is one kind of assembling loading and unloading platform, it is mainly composed of platform unit, steel structure rainshed and accessory equipment (folding stairs, loading arm, heat preservation building, etc.).

The surface of the platform is grid plate and checked plate with several methods of treatment for prevention corrosion such as painting, hot-dip zinc, electroplating and other technological process.

Steel structure canopy is installed on the ground by pillar, or directly installed on the platform, the roof surface is covered with color steel plate.

Assembling steel structure loading platform is the comprehensive operation platform which is equipped with fluid loading and unloading equipment for car and train, and is able to walk freely and safely.



Standard Emergency Shower and Eyewash



ESE

ESE-H

- | Model | ESE | ESE-H |
|--------------------|---|-------|
| Dimension | All height — 2350mm
Shower height — 2150mm
Eyewash height — 1080mm | |
| Bore | Supply water : 1-1/4" SUS304# stainless
Waste bore : 1-1/4" SUS304# stainless
Shower tube : 3/4" SUS304# stainless
Eyewash tube : 3/8" SUS304# stainless | |
| Connection | Supply water : 1-1/4" D (PT)
Waste bore : 1-1/4" D (PT) | |
| Spary head | Eyewash head : Nylon material , 50mmx44mm(H)
Include two kind filters ,
with yellow plastic floating cover ,
Basin dimension Ø345mm
Shower head : Nylon material ,
Dimension Ø200mm | |
| Hydraulic pressure | Above 1 kg/cm ² | |
| Action | Shower : A stainless actuator (stay open or close)
Eyewash :
Hand and foot operated Hand push plate
with special 8 shape
stainless chain | |
| Features | 1. All tubes are stainless SUS304# material , with special antirust process
2. Included sign (305 x 230mm , Chinese & English language with graph)
3. Meet ANSI Z 358.1-2014 ,
CNS 14251 T 2048-1998 , Din 12899 | |
| | Dimension Error ±2% | |

Nonpressurized Self-contained Eyewash



- Model EEW-NP
- Type Nonpressurized self-contained
- Operation Pull down green eyewash panel firmly. Eyewash panel will drop to activate equipment and start the water stream. User have to hold eyelids open and roll eyeball let water flow on all surfaces and infolds surrounding eyeball. After flushing for 15 mins, push up green eyewash panel to the original place, the water will stop.
- Tank Dimension: 550(W)x550(D)x650(H)mm
HDPE material, anti UV & against flame
- Volume 80 Liter
- Effective capacity 40L , supply for above 15 mins wash work.
- Eyewash plate Dimension: 204(W)x326(L)x111(H)mm
HDPE material, anti UV & against flame
- Spray head Nylon material, provide more 1.5L/min water.
- Supply water Input pipe is silicon material with seal for avoiding leaking
- Drain water bore 1/2" PVC pipe. Emissions waste water to sink or waste water bottle.
- Sign Above the equipment
Dimension : 185(W)x200(H)mm
- Operation instruction Above the equipment left side
Dimension: 100(W)x250(L)mm
- Maintenance instruction Above the equipment right side
Dimension: 100(W)x250(L)mm
- Orgcure 500ml, While change the water of equipment once a bottle.

Accessories

- EEW-NP-MC Roller car
Dimension: 600(W)x600(D)x750/850(H)mm
SUS304# stainless material
- EEW-NP-WB Waste liquid bottle
Dimension: 36x57(H)cm , 46ml
PE material
Include drain valve & sign
- Orgcure Preservative additive
Only for self-contained eyewash , 500ml





EW-First-1



EW-First-2

■ Features

1. Easy to install
Choose a suitable place from using screws or components to be wall-mounted.
2. Convenient to use
The special setting base can be easy to take off eyewash bottle for opening the cover as use at once, and it is efficient to help emergency accident for first step at primary time.
3. Easy to operate
Setting base and eyewash bottle have items of operation and attention, meanwhile those let the user understand and operated easily.
4. Special design of eyewash bottle
The design of eyewash bottle sare very conveninet to be held by operators and it is made LDPE material. Bottle can be kept pressing as easy to use, and press the saline solution for emergency wash eye.
5. Convenient to open a cover of eyewash bottle
A design in cover can be opened at primary time for supporting emergency accident. Furthermore, it is superior to prevent polluting the saline from dust and other matters.



EW-First-B

	EW-First-1	EW-First-2
• Model	EW-First-1	EW-First-2
• Dimension	220 (W) × 480 (H) × 98 (D) m m	440 (W) × 480 (H) × 98 (D) m m
• Setting base	Adopt to be made of ABS plastic material. The base is convenient to take off eyewash bottle, and prevent the bottle from falling down on the floor.	
• Operating paster	Size : 195x75mm Paster is made of water proof material, in addition it has Chinese/English bilingual edition that includes items of operation and attention for user understand and operation easily.	Size : 98x78mm User is convenient to check their face by themself for understand injured situation
• Mirror	None	
• Bottle quantity	One bottle Special design of bottle is convenient for works pressing and flushing the saline solution. LDPE material, 750ml Print the operations and cautions with English edition on bottle for convenient use.	Two bottles

INTRODUCTION

- The Stretcher Bed can be put into the water by manual throwing or automatic launching.
- The operator remotely controls the Stretcher Bed to reach the drowning person, and the rescued person can grip the handles or buckle up the rescue belt to get rid of risks by lying on the Stretcher Bed.
- For those with poor self-rescue ability, the Stretcher Bed can move backward to scoop up the drowning person and bring them back to shore.
- The Stretcher Bed is able to heat up automatically, which is convenient for rescue in cold weather and can help the drowning person's body temperature recover.



Save up to **4** Lives at a time
and Minimize Risk for Rescuers



HIGHLIGHTS

+ Ergonomic & Safety Design

+ Tangle-Free Propellers

+ Automatic Heating Device

+ High Visibility

+ Ease to Use & Deploy in Seconds

+ Powerful Motors & Strong Buoyancy

+ Small Volumn

+ Goods Transport

+ Low Battery Warning

+ High Speed

FEATURES



Dimension

1.68 × 0.73 × 0.26 m



Max. Speed

4.7 m/s



Weight

30 kg



Heating temp.

27.2°C



Endurance

60 min



Control Range

800 m

200 kg
Floatability (Max)



3~4 × Adults

SPECS

Dimension	1.19m(L) × 0.85m(W) × 0.2m(H)
Weight	13kg
Propulsion	Water-jet Thruster
Max. Speed	12km/h(3.6m/s)
Battery Life	30min@3.6m/s; 60min@1m/s
Floatability	225kg UP
Control Range	800m UP
Thruster Power	1800w
IP Rating	IP67



DOLPHIN 1 PLUS FEATURES



CERTIFICATIONS



Dolphin 1 Plus has numerous certificates accredited from audits, including RoHS, CE, FCC, and CCS. And it is widely applied in more than 30 countries.

APPLICATION



Beaches



Oil & Gas Platforms



Maritime Shipping



Yachts



Lakes, Rivers, Reservoirs

Floor Plate

SC-R Anti-slip floor plates are manufactured with the same materials as grating and stair treads. They are suitable for high exposure to salt water and offer high resistance to chemicals such as: acid, alkali and solvent liquids.

SC-R anti slip plates are non-conductive, non-magnetic and contain a fire retardant. Plates are approximately 4mm thick and supplied in different custom made sizes with a variety of anti-slip grits ranging from light to heavy duty. SC-R anti slip plates are ideal for wet or dry conditions where good slip resistance and traction are needed.

Staircare SC-R products are made to measure and since it is a finished product it can be used immediately.



Staircare SC-R Composite FRP Staircase Systems combine FRP grating, flooring, stair treads, structural shapes and handrails to an FRP System that provides non-corrosive, non-conductive resilient safe and versatile access.

Staircare SC-R Resilient, low maintenance FRP fiberglass reinforced polymer staircases built to measure, including embedded silicon carbide anti-slip grit for high slip resistance.

SC-R Solid Top Cover Grating

Molded square mesh with solid top cover offers bi-directional strength and are ideal for installations requiring multiple penetrations. Panels are available with silicon carbide anti-slip grit and offer light but strong Trench covers, Walkways, Cable troughs and Pit covers.

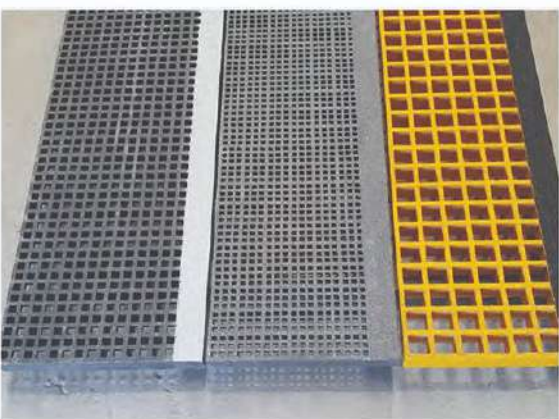

Staircare SC-R Made to Measure FRP Fabrication

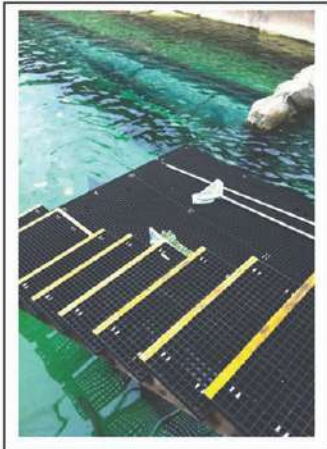

Flammable Cabinet

Specification:



Flammable Safety Cabinet										
Capacity	Number	Style of	Dimensions H*W*D/CM		Adjustable	Approved	N.W.	G.W.	Packing	Model
Gal/L	of Doors	Doors	Exterior	Interior	Shelves	Regulation	Kg	Kg	H*W*D/CM	No
4 Gal/15L	1	Manual Self-close	56*43*43	46*35*35	1	OSHA/NFPA CE/EN14470-1	27	35	72*53*53	SCM004Y SCS004Y
10 Gal/38L	1	Manual Self-close	64*59*60	54*51*52	1	OSHA/NFPA CE/EN14470-1	34	48	82*69*69	SCM010Y SCS010Y
12 Gal/45L	1	Manual Self-close	89*59*46	79*51*38	1	OSHA/NFPA CE/EN14470-1	44	56	108*70*57	SCM012Y SCS012Y
22 Gal/83L	1	Manual Self-close	165*60*46	154*52*38	3	OSHA/NFPA CE/EN14470-1	74	90	182*70*57	SCM022Y SCS022Y
30 Gal/114L	2	Manual Self-close	112*109*46	102*101*38	1	OSHA/NFPA CE/EN14470-1	86	102	130*120*57	SCM030Y SCS030Y
45 Gal/170L	2	Manual Self-close	165*109*46	155*101*38	2	OSHA/NFPA CE/EN14470-1	114	133	182*120*57	SCM045Y SCS045Y
54 Gal/204L	1	Manual Self-close	165*60*87	155*52*79	3	OSHA/NFPA CE/EN14470-1	120	140	184*70*97	SCM054Y SCS054Y
60 Gal/227L	2	Manual Self-close	165*86*86	155*78*78	2	OSHA/NFPA CE/EN14470-1	144	166	182*96*96	SCM060Y SCS060Y
90 Gal/340L	2	Manual Self-close	165*109*86	155*101*78	2	OSHA/NFPA CE/EN14470-1	164	186	182*120*96	SCM090Y SCS090Y

Spill Containment pallet

Specification:



Poly Spill Pallet								
Capacity	Drum	Loading	Mobile	N.W.	G.W.	Forklift	Dimension	Model
Gal/L	Quantity	Weight	Type	Kg	Kg	Operation	H*W*D/CM	No
40/150	2	1300	Not Mobile	17	18	2 Side Operation	30*130*71	PSP102
53/200	4	2700	Not Mobile	34	35	4 Side Operation	30*130*130	PSP104

Project Gallery

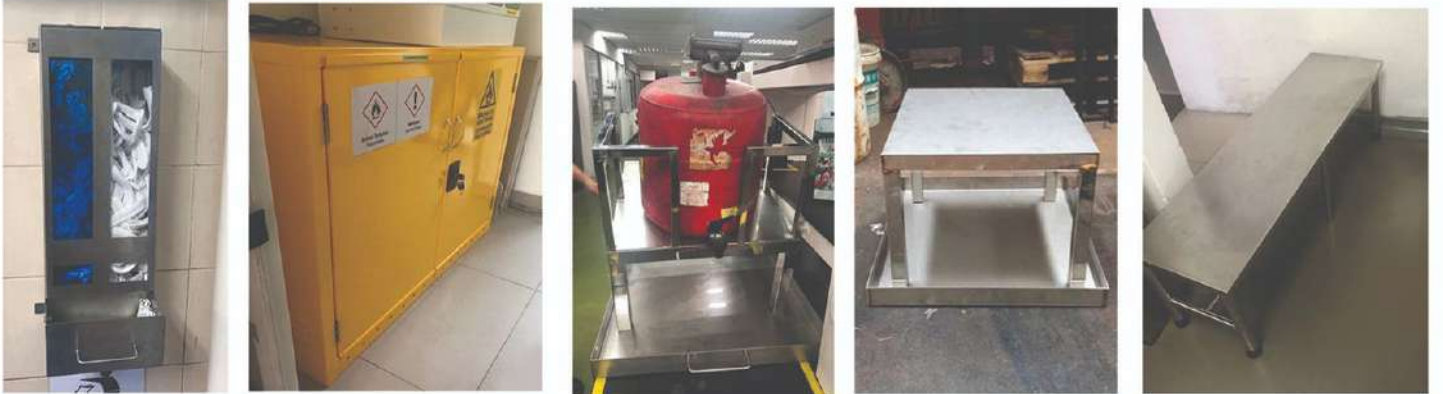

Project Gallery



Project Gallery



Project Gallery

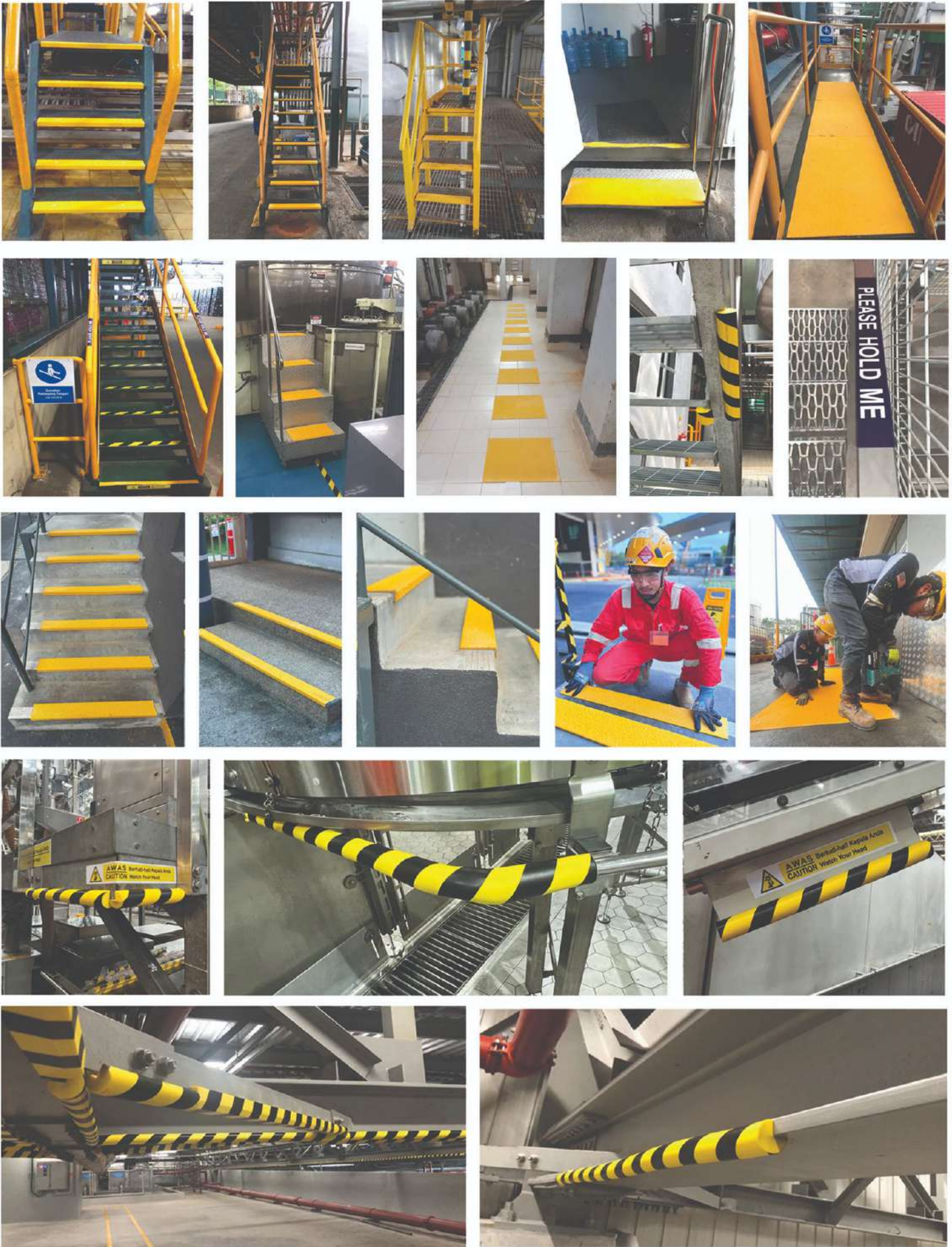

Project Gallery



Project Gallery

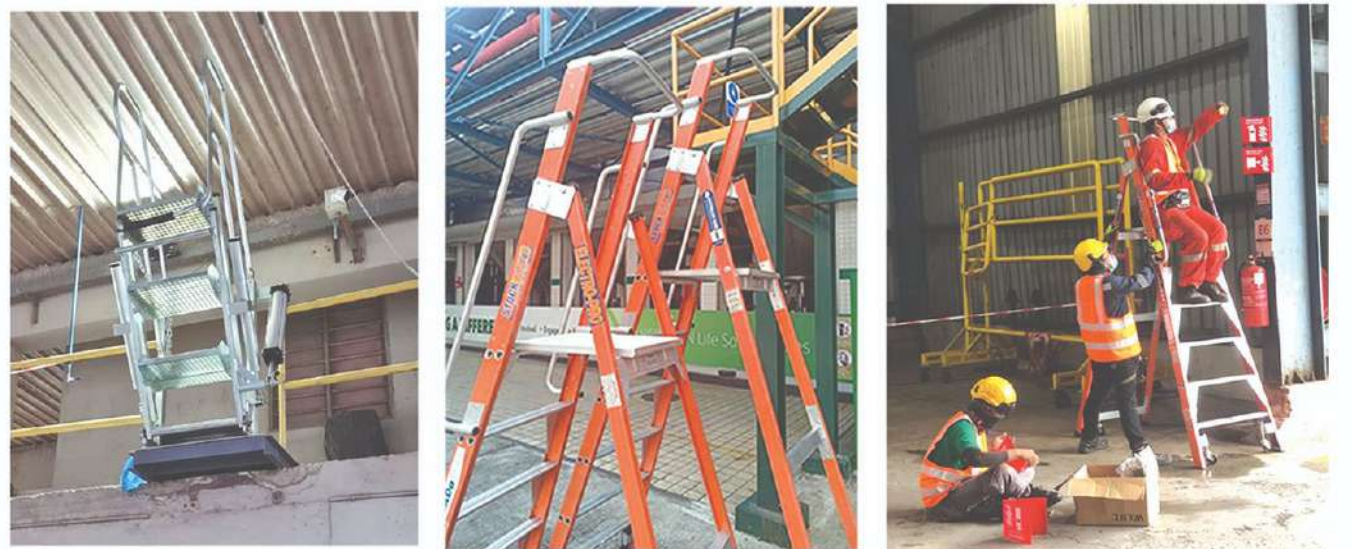

Project Gallery



Project Gallery

